

# Worldwide Storage Solutions

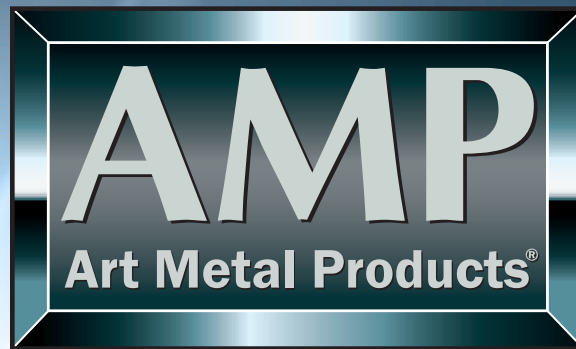

## FULL LINE CATALOG

**Manufacturing Since 1914**



- WELDED & KD LOCKERS
- CUSTOM WOOD LOCKERS
- PHENOLIC LOCKERS
- PLASTIC LOCKERS
- ALL-WELDED CUBBIES
- LOCKER LOCKS
- BENCHES & PEDESTALS
- BULK STORAGE LOCKERS
- STORAGE CABINETS
- STEEL SHELVING
- BOLTLESS SHELVING
- PORTABLE GATES

**[www.ArtMetalProducts.com](http://www.ArtMetalProducts.com)**



## FROM OUR FAMILY TO YOURS



**JR LIST  
PRESIDENT**

We have earned the respect of our customers and competitors because of our dedication to quality. Customer feedback has paved the way for the inclusion of knock-down lockers, steel shelving, rivet-type shelving, bulk storage lockers, portable gates, all-welded cubbies and storage cabinets into our product line offerings.

With the addition of our new state-of-the-art powder coat finishing system, we are prepared to meet the demands of today's market while doing our share to help improve our environment. We have also added many new products such as plastic lockers, specialty lockers, industry specific lockers, extreme performance lockers, an expanded line of wood & phenolic lockers and our national distribution system, with six national distribution centers to greatly speed up delivery in all 50 states.

Our diverse product line and custom manufacturing process allows us the flexibility to create lockers, cabinets and shelving to meet and exceed all of your requirements. Our wide variety of colors also allows you to easily incorporate our products into your designs.

I am proud to be at the helm of Art Metal Products, along with a team of dedicated professionals that are driven to meet client needs on a consistent basis, delivering quality and innovative products. We have also elevated the concept of "service" to an art form.

We have strived, since acquiring Art Metal Products, to continue a tradition of high quality products and timely deliveries, second to none. This we have done!

## SETTING THE STANDARD FOR QUALITY SINCE 1914.

Art Metal Products, are manufactured in our two modern, highly efficient, state-of-the-art facilities in Deerfield Beach and Apopka, Florida. We recently expanded capacity, making room for the installation of five million dollars' worth of computer-controlled fabricating, roll-forming and powder coat finishing systems to ensure consistent, quality workmanship.

Our top-of-the-line, automatic, numerically controlled, quick color change finishing system allows us to offer 24 standard designer powder coat applied colors with the highest quality and most durable paint finish in the industry.

From initial design to manufacture and finish, Art Metal Products lockers are engineered using the most advanced computer technology to give you quality you can rely on.

Our complete line of ProSport Lockers offers you twelve standard configurations per size, before adding options to further meet your needs. The expansion of our Recruiter™ wood and Phenolic Lockers lines insures a locker to meet your specific facility needs



### Turret Press

This catalog depicts just a few of the endless design possibilities when choosing Art metal Product lockers; it also includes other product lines, all manufactured to the same high standards you have come to expect. We welcome the opportunity to work directly with you to custom design a locker room environment that is productive and attractive while remaining time and cost efficient.

Our team of designers, engineers and sales professionals is available to assist you every step of the way, from initial budget planning to final project closeout.

Art Metal Products leads the way in quality and customer service. From our corporate headquarters in Deerfield Beach, our three manufacturing plants in Florida, six strategically located regional distribution centers, seven regional sales offices located throughout the United States and our network of more than 100 authorized distributors nationwide, we provide the quality you demand, the timeliness you require and the service you deserve.



## All AMP metal and plastic lockers are Greenguard Gold Certified.

Greenguard is an indoor air quality certification program for low emitting products and materials that evaluates over 75,000 chemicals, including volatile organic compounds, carcinogens, and reproductive toxins. Referenced in both the Collaborative for High Performance Schools (CHPS) and the Leadership for



Energy and Environment Design (LEED) Building Rating System, Greenguard Gold Certification establishes strict chemical emission standards for products intended for use in environments where children and others work, play or reside.



## GALVANITE™ CORROSION RESISTANT SHEET STEEL

*Ideal for use in high humidity areas, outdoor locations, near shower, pool areas and food industry facilities*

**GALVANITE™**, is Art Metal Products trade marked name for lockers and cabinets manufactured with galvanneal sheet steel components and finished with an electrostatically applied high-grade powder coat finish. Galvanite and powder coat offer exceptional double protection against corrosion, even under the most adverse conditions. Tests indicate that galvanneal increases the estimated life cycle threefold.

### What Is Galvanneal?

Galvanneal is the result of the combined processes of galvanizing (hot-dipped zinc coating) and annealing (heat treatment). Galvanneal does not flake off its galvanized coating when formed, stamped, and bent. The very fine matte finish acts like a primer that easily adheres to paint. These characteristics make galvanized sheet steel ideal for steel lockers in high humidity, corrosion prone areas.

**GALVANNEAL SHEET STEEL**  
with our powder coat finish after a 336 hour salt spray test.



**COMMON COMMON ROLLED SHEET STEEL**  
with a 1 mil dry film build paint thickness after a 336 hour spray test.



### TABLE OF CONTENTS

| PRODUCTS                                       | PAGE  |
|--|-------|
| Twin-Framed All-Welded Production Lockers..... | 5     |
| Task ForceXP All-Welded Lockers .....          | 21    |
| Turnout Gear Fully Framed Lockers .....        | 22    |
| TA-50 Fully Framed Military Gear Lockers ..... | 24    |
| Welded Cubbies .....                           | 26    |
| Knock-Down (KD) Production Lockers .....       | 28    |
| Benches & Pedestals.....                       | 40    |
| Locks .....                                    | 41    |
| Cubix Lockers .....                            | 43    |
| Backpack/Laptop lockers .....                  | 44    |
| Cell Phone lockers.....                        | 45    |
| Bulk Storage Lockers (BSL).....                | 46    |
| Parcel Lockers .....                           | 48    |
| Portable Gates .....                           | 49    |
| Wood Lockers .....                             | 50    |
| AquaMax™ HDPE Solid Plastic Lockers.....       | 56    |
| VersaMax™ Phenolic Lockers .....               | 58    |
| HiTech® Clip Shelving .....                    | 60    |
| DuraTech™ PassThru Shelving .....              | 66    |
| Rivetwell™ Boltless Shelving .....             | 68    |
| 400-800 Series KD Cabinets .....               | 76    |
| DuraTough™ All Welded Cabinets .....           | 80    |
| Color Options.....                             | 84-85 |
| Quick-Ship Program .....                       | 86    |



*Manufacturing facilities where Art Metal Products are made in Deerfield Beach, Florida.*



# INNOVATIONS THAT MAKE US THE INDUSTRY LEADER...

## OUR STEEL

Most of our steel is purchased directly from US mills and is made of 30% post consumer recycled content and 11.3% post industrial/pre-consumer content.

## OUR PAINT

Sherwin Williams powders are made in the USA insuring no harmful materials.

**Hammertone** textured finishes are available for all 24 standard colors.

**Medsafe**® antimicrobial finishes with Microban® are available for all 24 colors



## WE ARE GREENGUARD GOLD CERTIFIED

GREENGUARD Gold Certification establishes strict chemical emission standards for products intended for use in environments where children and others work, play or reside.

## AMP LOCKERS LOCK BARS ARE INSTALLED AFTER THE DOORS ARE PAINTED



LOCK CHANNEL

### Roll formed G90 Hot dipped galvanized lock bars

are installed after the doors are painted to ensure complete paint coverage, corrosion resistance and smoother lock bar operation. Others use standard steel and/or install the lock channel before paint trapping moisture in, preventing proper paint coverage leading to corrosion problems.

Dupont® Supertough® nylon latches are made in the USA and are installed after paint to insure a lifetime of performance. Use of lower quality plastics and/or installing before paint can cause brittleness and poor performance.



Available for all standard 24 colors

Our MedSafe™ antimicrobial finishes with Microban® are specially formulated to protect against bacteria, mold, yeast & mildew for up to 20 years! Very beneficial for educational, healthcare, food processing and other hygiene conscious environments.



# TWIN-FRAME ALL-WELDED LOCKERS



## What Are Twin-Frame™ All-Welded Lockers?

**Art Metal Products Twin-Frame all-welded lockers include our twin vertical frame design adding strength, integrity, durability and added visual appeal.**

- First we start with prime grade cold rolled sheet steel, 16 gauge for all components except backs which are 18 gauge and doors which are 14 gauge.
- Sides are formed to be an integral part of the front vertical locker frame which locks into the bottom for accurate alignment and added strength
- We MIG weld an additional channel shaped vertical frame member at intermediate dividers providing a continuous door strike at both the hinge and latch side of the door
- The top and bottom are flanged downward at the front to form a 1-1/2" high channel shaped top and bottom horizontal frame member continuous across the multiple column unit up to 60" wide
- The base is a full 1-1/2" high keeping locker contents away from moisture on the floor and/or wood/concrete base.
- Front-to-back channel stiffeners are welded into the base under each side panel providing a strong anchor bearing surface for installation and increasing overall unit strength.
- Horizontal tier dividers for double and triple tier models project through to the face of the locker forming a horizontal cross member between doors for maximum strength
- All doors are heavy 14 gauge. A full-height vertical door stiffener welded to the hinge side of the door is available in our Elite series and standard in our Bulldog models when maximum door strength is desired
- Recessed handle wardrobe models AMP-1002, AMP-1003, AMP-1004 and AMP-1005 include our deep-drawn seamless 304 stainless steel recessed handle. AMP-1006 box lockers are also available with optional recessed handle (see page 24 for details)
- All doors are right hand hinged using our 16 gauge continuous piano hinge
- Engineered to last the lifetime of your facility. We guarantee it with our lifetime warranty on all Twin-Frame all-welded lockers.

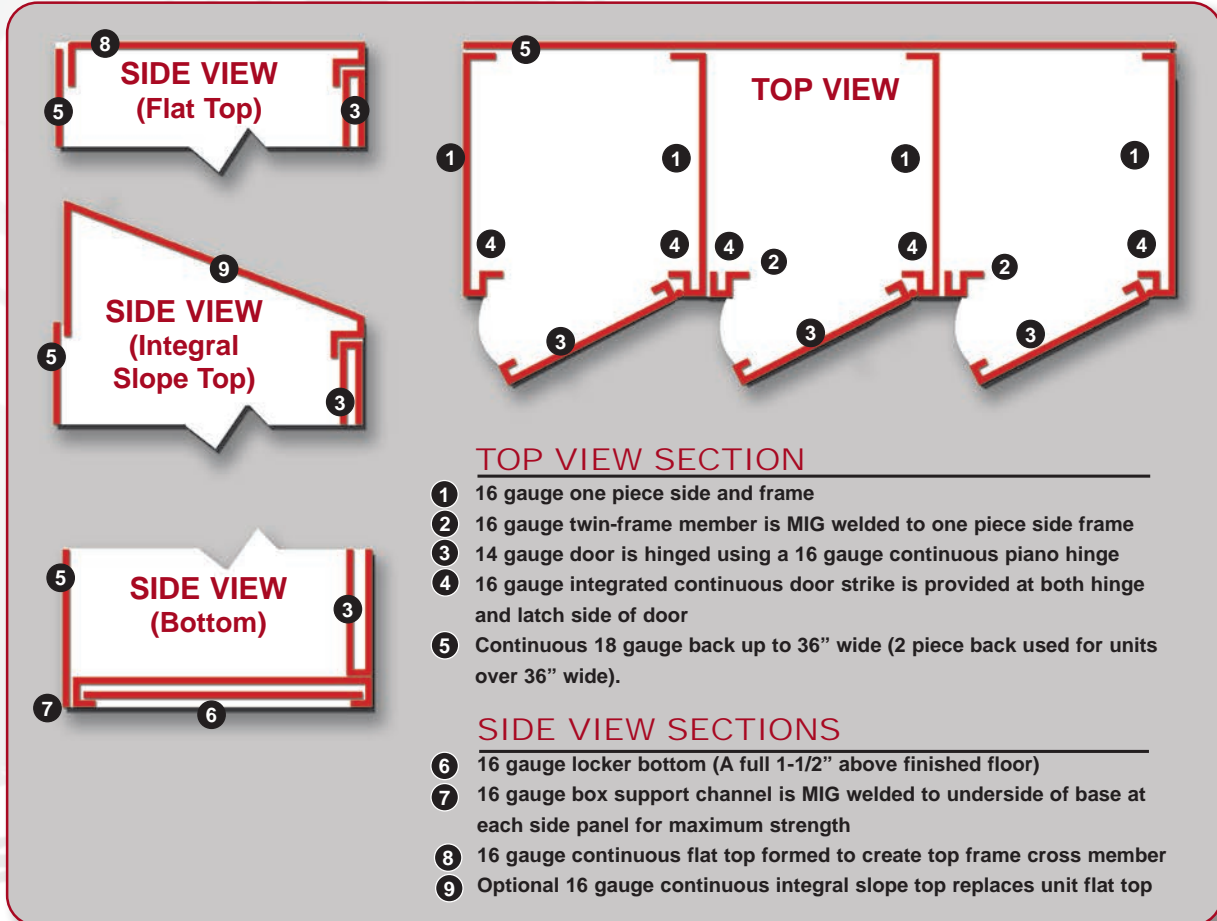

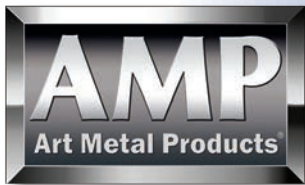

## TWIN-FRAME ALL-WELDED SPORT LOCKERS



Our complete line-up of open-front sport lockers is a collection of specialty lockers engineered for high school, collegiate and professional team organizations who demand high performance equipment storage solutions.

Our Pro-Sport Twin-Frame all-welded open-front athletic lockers are designed to accommodate the storage of a wide variety of athletic gear and apparel while allowing maximum ventilation.

Base model Pro-Sport locker includes one upper hat shelf with a compliment of coat hooks. You can add a choice from three upper security compartments for personal storage: a small wallet security box, a 12" wide side hinged security box or the full width top hinged security compartment.

In the lower area, you can add a shelf/seat or opt for the foot locker/seat for a lockable equipment storage area. You can complete your Pro-Sport locker with our optional stainless steel coat rod.

Our Twin-Frame design which provides two front frame channels between sides of multiple column units and integral sides which are diamond perforated for ventilation. Pro-Sport lockers are engineered to last the lifetime of your facility. We guarantee it!

Shown with optional 12" wide security box, stainless steel coat rod and foot locker/seat

### PRO-SPORT LOCKER SIZES:

Widths 18", 24", 30", 33" & 36"  
Depths 16", 18", 22"  
Column Heights 60", 72", 84"

Note: Pro-Sport lockers will ship in multiple column units up to 60" wide to meet individual jobsite conditions.



Optional integral slope top 16 gauge steel, runs continuous across a multiple column unit and is MIG welded at the factory replacing welded locker unit flat top. Sides are sloped at top providing rigid support beneath the slope top between each locker column.

# FEATURES & OPTIONS

CONFIGURATIONS DESIGNED TO MEET YOUR LOCKER NEEDS

## UPPER OPTIONS

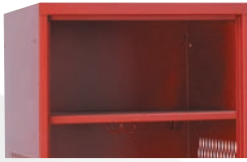

Open top shelf with under hang hooks



Upper wallet security box with stainless steel coat rod



12" wide security box with stainless steel coat rod



Full width security box with stainless steel coat rod

## LOWER OPTIONS



Open lower



Reinforced seat



Foot locker with reinforced seat



Underside of foot locker seat is reinforced to support today's athlete

## ADDITIONAL OPTIONS



Shoulder pad rack



Shoulder pad rack with helmet support



2" or 3" Padded seat cushion

### A POPULAR CONFIGURATION

Shown here with full width security compartment, stainless steel coat rod and lower shelf/seat. Both security compartment sides are ventilated. See page 88 for color selections.

### LOCKER SIZES

**Widths** 18", 24", 30", 33", 36"

**Depths** 12", 16", 18", 22"

**Nominal Heights** 60", 72", 84"

## FEATURES

**BODY CONSTRUCTION:** Twin-Frame all-welded construction, 16 gauge 1-1/2" high continuous bottom with reinforcing channels welded to the underside at each side panel providing a rigid unit base, 16 gauge continuous top, 16 gauge diamond perforated sides are integral with front vertical frame, 18 gauge solid back

**SECURITY BOX DOORS:** 14 gauge diamond perforated doors are standard. Plain, Secure-Air-Flow, and louvered door styles are available.

**HINGES:** 16 gauge continuous piano type

**OPTIONAL LOWER SEAT/SHELF:** Shall be 16 gauge 1" with a reinforcing bar welded to lower front for rigidity.

**OPTIONAL FOOT LOCKER:** 14 gauge cold rolled steel with Secure-Air-Flow mini louvers ventilation, seat opens for storage .

**STANDARD:** hat shelf and two single prong wall hooks, one double prong ceiling hook.

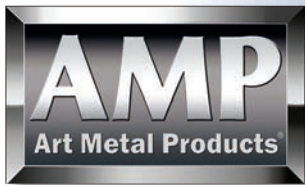

# AMP-1001 3 POINT TURN-HANDLE ATHLETIC LOCKERS



**LIFETIME WARRANTY**



**TWIN FRAME ALL-WELDED**

*Guaranteed for the life of your facility!*

*This 3-point positive latching system all-welded locker is one of the most rugged and durable lockers currently available.*

Engineered to utilize our new Twin-Frame all-welded construction, AMP-1001 lockers are manufactured to be both secure and durable to hold up to the abuse of today's athletes. Positive latching is achieved using a 3-point turn-handle locking mechanism which when locked, provides maximum security. With the simple action of turning the handle, 3/8" diameter lock rods engage the frame through guide holes in the return flanges of the locker top and bottom while simultaneously, a heavy-gauge latch rotates behind the continuous door strike which is an integral part of the vertical frame.



### STANDARD SIZES FOR ALL TWIN-FRAME ALL-WELDED WARDROBE LOCKERS

#### **SINGLE TIER**

Widths 9", 12", 15", 18", 24"

Depths 12", 16", 18", 22"

Column Heights 36", 48", 60", 72"

#### **DOUBLE TIER**

Widths 9", 12", 15", 18", 24"

Depths 12", 16", 18", 22"

Opening Heights 24", 30", 36"

Column Heights 48", 60", 72"

#### **TRIPLE TIER**

Widths 9", 12", 15", 18", 24"

Depths 12", 16", 18", 22"

Opening Heights 20", 24"

Column Heights 60", 72"

*All welded lockers will ship in multiple column units up to 60" wide to meet individual job site conditions*



# FEATURES & OPTIONS



## AMP-1001 Turn-Handle Athletic Twin-Frame All-Welded Lockers



**AMP-1001 ELITE SERIES LOCKERS** which include a 3" wide 18 gauge full height door stiffener spot welded to the inner door face and MIG welded to the hinge side as well as to the top and bottom door flanges providing a rigid torque-free door. A 1-1/2" wide stiffener will be furnished for 12" wide AMP-1001E Elite Series lockers.

**Not available in 9" wide lockers**



**OPTIONAL INTEGRAL SLOPE TOP** 16 gauge steel, runs continuous across a multiple column unit and is MIG welded at the factory replacing welded locker unit flat top. Sides are sloped at top providing rigid support beneath the slope top between each locker column.



### 3-POINT HIGH SECURITY TURN HANDLE

3-point turn-handle latching engaging at frame top, bottom and center side of door, 3/8" diameter lock rods are the heaviest in the industry, 3/16" turn-handle welded to 11 gauge cam, 11 gauge lock plate keeper is welded to center side of frame  
Not available in 9" wide lockers.



**DOOR HINGES:** Hinges for wardrobe doors shall not be less than 16 gauge continuous piano type, securely riveted to frame and welded to the door. All doors shall be right hand side hinged.

## AMP-1001 FEATURES

**BODY CONSTRUCTION:** Twin-Frame all-welded construction, 16 gauge 1-1/2" high continuous bottom with reinforcing channels welded to the underside at each side panel providing a rigid unit base, 16 gauge continuous top, 16 gauge diamond perforated sides are integral with front vertical frame, 18 gauge solid back

**DOORS:** 14 gauge diamond perforated doors are standard. Plain, Secure-Air-Flow, and louvered door styles are available

**HANDLE:** 3-point turn-handle latching

**DOOR STRIKE:** Continuous vertical door strike at both hinge and latch side

**LATCHING:** 3-point turn-handle latching engaging at frame top, bottom and center side of door, 3/8" diameter lock rods are the heaviest in the industry, 3/16" turn-handle welded to 11 gauge cam, 11 gauge lock plate keeper is welded to center side of frame

**HINGES:** 16 gauge continuous piano type

**SHELVES:** 16 gauge hat shelf for single tier openings 60" and 72" high, 16 gauge intermediate shelves

**HOOKS:** 2-single hooks and 1-double hook is standard. 1-double hook only for triple tier and 1-double and 1-single hook for 9" wide openings 30" and higher

**SIZES:** See chart on pg 8 for standard wardrobe locker sizes



# AMP-1002 CHAMP ATHLETIC LOCKERS

**LIFETIME WARRANTY** **TWIN FRAME ALL-WELDED**



*Our stylish Twin-Frame all-welded locker with the deep-drawn seamless stainless steel recessed handle is the perfect choice for the demanding designer.*

These are our most popular athletic lockers and for good reason. AMP-1002 lockers incorporate our proven gravity lift-type latching mechanism for a smooth, quiet and dependable operation. Champ Athletic lockers are perfect for use in combination with welded box lockers in P.E. locker rooms.

### STANDARD SIZES FOR ALL TWIN-FRAME ALL-WELDED WARDROBE LOCKERS

**SINGLE TIER**

Widths 9", 12", 15", 18", 24"

Depths 12", 16", 18", 22"

Column Heights 36", 48", 60", 72"

**DOUBLE TIER**

Widths 9", 12", 15", 18", 24"

Depths 12", 16", 18", 22"

Opening Heights 24", 30", 36"

Column Heights 48", 60", 72"

**TRIPLE TIER**

Widths 9", 12", 15", 18", 24"

Depths 12", 16", 18", 22"

Opening Heights 20", 24"

Column Heights 60", 72"

*All welded lockers will ship in multiple column units up to 60" wide to meet individual job site conditions*

# FEATURES & OPTIONS



## AMP-1002 champ athletic Twin-Frame All-Welded Lockers



**AMP-1002E ELITE SERIES LOCKERS** which include a 3" wide 18 gauge full height door stiffener spot welded to the inner door face and MIG welded to the hinge side as well as to the top and bottom door flanges providing a rigid torque-free door. A 1-1/2" wide stiffener will be furnished for 9" wide AMP-1002E Elite Series lockers.



**OPTIONAL INTEGRAL SLOPE TOP** 16 gauge steel, runs continuous across a multiple column unit and is MIG welded at the factory replacing welded locker unit flat top. Sides are sloped at top providing rigid support beneath the slope top between each locker column.



### DEEP-DRAWN 304 STAINLESS STEEL RECESSED HANDLE

All locker doors shall have a deep-drawn seamless not less than 304 stainless steel recessed handle shaped to receive a padlock or built-in combination lock. The recess pan shall be deep enough to have the lock be completely flush with the outer door face.



**DOOR HINGES:** Hinges for wardrobe doors shall not be less than 16 gauge continuous piano type, securely riveted to frame and welded to the door. All doors shall be right hand side hinged.

### AMP-1002 FEATURES

**BODY CONSTRUCTION:** Twin-Frame all-welded construction, 16 gauge 1-1/2" high continuous bottom with reinforcing channels welded to the underside at each side panel providing a rigid unit base, 16 gauge continuous top, 16 gauge diamond perforated sides are integral with front vertical frame, 18 gauge solid back

**DOORS:** 14 gauge louvered doors are standard. Plain, Secure-Air-Flow, Safety-View and louvered door styles are available  
handle: Deep-drawn seamless stainless steel recessed handle  
door strike: Continuous vertical door strike at both hinge and latch side

**LATCHING:** 12 gauge latch hooks MIG welded to frame, gravity lift-type multi-point spring loaded latching:

- 3-point latching for openings 48" high and higher
- 2-point latching for openings 20" high thru 36" high

**HINGES:** 16 gauge continuous piano type

**SHELVES:** 16 gauge hat shelf for single tier openings 60" and 72" high, 16 gauge intermediate shelves

**HOOKS:** 2-single hooks and 1-double hook is standard. 1-double hook only for triple tier and 1-double and 1-single hook for 9" wide openings 30" and higher

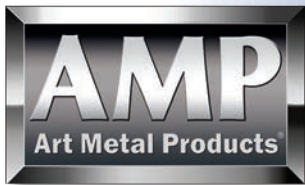

# AMP-1003 CHAMP CORRIDOR LOCKERS

 **LIFETIME WARRANTY**

 **TWIN FRAME ALL-WELDED**

*With louvered doors, solid sides and our deep-drawn seamless stainless steel recessed handle with gravity lift-type latching mechanism, our AMP-1003 lockers are the top choice for corridor and staff lockers.*



**THE NEW Z-TIER UNIBODY LOCKERS** creates a unique multi-height storage with extended hanging space on one side and built in shelf on the other, its like a two tier with the space of a single tier.

## STANDARD SIZES FOR ALL TWIN-FRAME ALL-WELDED WARDROBE LOCKERS

### SINGLE TIER

Widths 9", 12", 15", 18", 24"  
 Depths 12", 16", 18", 22"  
 Column Heights 36", 48", 60", 72"

### DOUBLE TIER

Widths 9", 12", 15", 18", 24"  
 Depths 12", 16", 18", 22"  
 Opening Heights 24", 30", 36"  
 Column Heights 48", 60", 72"

### TRIPLE TIER

Widths 9", 12", 15", 18", 24"  
 Depths 12", 16", 18", 22"  
 Opening Heights 20", 24"  
 Column Heights 60", 72"

### Z-STYLE

Widths 12", 15", 18"  
 Depths 12", 16", 18", 22"  
 Opening Heights 24/36", 30/42"  
 Column Heights 60", 72"

*All welded lockers will ship in multiple column units up to 60" wide to meet individual job site conditions*

# FEATURES & OPTIONS



## AMP-1003 Champ Corridor Twin-Frame All-Welded Lockers



**AMP-1003E ELITE SERIES LOCKERS** which include a 3" wide 18 gauge full height door stiffener spot welded to the inner door face and MIG welded to the hinge side as well as to the top and bottom door flanges providing a rigid torque-free door. A 1-1/2" wide stiffener will be furnished for 9" wide AMP-1003E Elite Series lockers.



**OPTIONAL INTEGRAL SLOPE TOP** 16 gauge steel, runs continuous across a multiple column unit and is MIG welded at the factory replacing welded locker unit flat top. Sides are sloped at top providing rigid support beneath the slope top between each locker column.



### DEEP-DRAWN 304 STAINLESS STEEL RECESSED HANDLE

All locker doors shall have a deep-drawn seamless not less than 304 stainless steel recessed handle shaped to receive a padlock or built-in combination lock. The recess pan shall be deep enough to have the lock be completely flush with the outer door face.



**DOOR HINGES:** Hinges for wardrobe doors shall not be less than 16 gauge continuous piano type, securely riveted to frame and welded to the door. All doors shall be right hand side hinged.

### AMP-1003 FEATURES

**BODY CONSTRUCTION:** Twin-Frame all-welded construction, 16 gauge 1-1/2" high continuous bottom with reinforcing channels welded to the underside at each side panel providing a rigid unit base, 16 gauge continuous top, 16 gauge solid sides are integral with front vertical frame, 18 gauge solid back

**DOORS:** 14 gauge louvered doors are standard. Plain, Secure-Air-Flow, Safety-View and diamond perforated door styles are available

**HANDLE:** Deep-drawn seamless stainless steel recessed handle

**DOOR STRIKE:** Continuous vertical door strike at both hinge and latch side

**LATCHING:** 12 gauge latch hooks MIG welded to frame, gravity lift-type multi-point spring loaded latching:

- 3-point latching for openings 48" high and higher
- 2-point latching for openings 20" high thru 36" high

**HINGES:** 16 gauge continuous piano type

**SHELVES:** 16 gauge hat shelf for single tier openings 60" and 72" high, 16 gauge intermediate shelves

**HOOKS:** 2-single hooks and 1-double hook is standard. 1-double hook only for triple tier and 1-double and 1-single hook for 9" wide openings 30" and higher

**SIZES:** See page 14 for standard wardrobe locker sizes

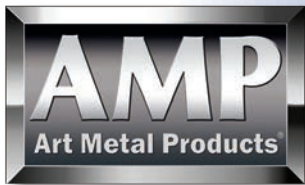

# AMP-1004 BULLDOG ATHLETIC LOCKERS



*This premium athletic locker with single-point latching mechanism has no moving parts providing quiet and maintenance-free operation.*

Our Twin-Frame design, deep-drawn seamless stainless steel recessed handle, continuous piano hinge and torque-free reinforced heavy-gauge door are standard for AMP-1004 Bulldog athletic lockers making them the perfect choice for your athletic locker areas.



### STANDARD SIZES FOR ALL TWIN-FRAME ALL-WELDED WARDROBE LOCKERS

**SINGLE TIER**

Widths 9", 12", 15", 18", 24"

Depths 12", 16", 18", 22"

Column Heights 36", 48", 60", 72"

**DOUBLE TIER**

Widths 9", 12", 15", 18", 24"

Depths 12", 16", 18", 22"

Opening Heights 24", 30", 36"

Column Heights 48", 60", 72"

**TRIPLE TIER**

Widths 9", 12", 15", 18", 24"

Depths 12", 16", 18", 22"

Opening Heights 20", 24"

Column Heights 60", 72"

*All welded lockers will ship in multiple column units up to 60" wide to meet individual job site conditions*

# FEATURES & OPTIONS



## AMP-1004 Bulldog Athletic Twin-Frame All-Welded Lockers



**BULLDOG LOCKERS** include a 3" wide 18 gauge full height door stiffener spot welded to the inner door face and MIG welded to the hinge side as well as to the top and bottom door flanges providing a rigid torque-free door. A 1-1/2" wide stiffener will be furnished for 9" wide AMP-1004 Bulldog lockers.



**OPTIONAL INTEGRAL SLOPE TOP** 16 gauge steel, runs continuous across a multiple column unit and is MIG welded at the factory replacing welded locker unit flat top. Sides are sloped at top providing rigid support beneath the slope top between each locker column.



**BULLDOG DEEP-DRAWN SEAMLESS STAINLESS STEEL RECESSED HANDLE:** All locker doors shall have a deep-drawn seamless not less than 304 stainless steel recessed handle shaped to receive a padlock or built-in combination lock. The recess pan shall be deep enough to have the lock be completely flush with the outer door face. The pull handle shall be drawn into the left side of the handle for easy opening of the locker door.



**DOOR HINGES:** Hinges for wardrobe doors shall not be less than 16 gauge continuous piano type, securely riveted to frame and welded to the door. All doors shall be right hand side hinged.

### AMP-1004 FEATURES

**BODY CONSTRUCTION:** Twin-Frame all-welded construction, 16 gauge 1-1/2" high continuous bottom with reinforcing channels welded to the underside at each side panel providing a rigid unit base, 16 gauge continuous top, 16 gauge diamond perforated sides are integral with front vertical frame, 18 gauge solid back

**DOORS:** 14 gauge diamond perforated doors and 18 gauge full-height door stiffener are standard. Plain, Secure-Air-Flow and louvered door styles are available

**HANDLE:** Deep-drawn seamless stainless steel recessed handle is standard.

**DOOR STRIKE:** Continuous vertical door strike at both hinge and latch side

**LATCHING:** Single-point maintenance-free quiet latching

System with 11 gauge MIG welded latch

**HINGES:** 16 gauge continuous piano type

**SHELVES:** 16 gauge hat shelf for single tier openings 60" and 72" high, 16 gauge intermediate shelves

**HOOKS:** 2-single hooks and 1-double hook is standard. 1-double hook only for triple tier and 1-double and 1-single hook for 9" wide openings 30" and higher

**SIZES:** See page 14 for standard wardrobe locker sizes

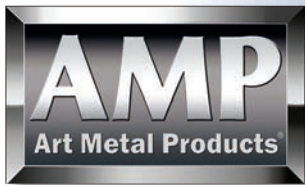

# AMP-1005 BULLDOG CORRIDOR LOCKERS



**LIFETIME WARRANTY**



**TWIN FRAME ALL-WELDED**

*Our single-point all-welded corridor lockers have achieved a standard of excellence that only Art Metal Products can provide.*

With the elegance of our Twin-Frame design, smooth deep drawn seamless stainless steel recessed handle, continuous piano hinge and torque-free reinforced heavy-gauge door, you can rest assured that you have chosen a locker which will enhance the architectural design of your facility while providing a lifetime of maintenance-free use.



**NEW Z-TIER UNIBODY** lockers creates a unique multi-height storage with extended hanging space on one side and built in shelf on the other, its like a two tier with the space of a single tier.

## STANDARD SIZES FOR ALL TWIN-FRAME ALL-WELDED WARDROBE LOCKERS

### SINGLE TIER

Widths 9", 12", 15", 18", 24"  
 Depths 12", 16", 18", 22"  
 Column Heights 36", 48", 60", 72"

### DOUBLE TIER

Widths 9", 12", 15", 18", 24"  
 Depths 12", 16", 18", 22"  
 Opening Heights 24", 30", 36"  
 Column Heights 48", 60", 72"

### TRIPLE TIER

Widths 9", 12", 15", 18", 24"  
 Depths 12", 16", 18", 22"  
 Opening Heights 20", 24"  
 Column Heights 60", 72"

### Z-STYLE

Widths 12", 15", 18"  
 Depths 12", 16", 18", 22"  
 Opening Heights 24/36", 30/42"  
 Column Heights 60", 72"

*All welded lockers will ship in multiple column units up to 60" wide to meet individual job site conditions*



## FEATURES & OPTIONS



### AMP-1005 Bulldog Corridor Twin-Frame All-Welded Lockers



**BULLDOG LOCKERS** include a 3" wide 18 gauge full height door stiffener spot welded to the inner door face and MIG welded to the hinge side as well as to the top and bottom door flanges providing a rigid torque-free door. A 1-1/2" wide stiffener will be furnished for 9" wide AMP-1005 Bulldog lockers.



**OPTIONAL INTEGRAL SLOPE TOP** 16 gauge steel, runs continuous across a multiple column unit and is MIG welded at the factory replacing welded locker unit flat top. Sides are sloped at top providing rigid support beneath the slope top between each locker column.



**BULLDOG DEEP-DRAWN SEAMLESS STAINLESS STEEL RECESSED HANDLE:** All locker doors shall have a deep-drawn seamless not less than 304 stainless steel recessed handle shaped to receive a padlock or built-in combination lock. The recess pan shall be deep enough to have the lock be completely flush with the outer door face. The pull handle shall be drawn into the left side of the handle for easy opening of the locker door.



**DOOR HINGES:** Hinges for wardrobe doors shall not be less than 16 gauge continuous piano type, securely riveted to frame and welded to the door. All doors shall be right hand side hinged.

### AMP-1005 FEATURES

**BODY CONSTRUCTION:** Twin-Frame all-welded construction, 16 gauge 1-1/2" high continuous bottom with reinforcing channels welded to the underside at each side panel providing a rigid unit base, 16 gauge continuous top, 16 gauge solid sides are integral with front vertical frame, 18 gauge solid back

**DOORS:** 14 gauge plain doors and a full-height door stiffener are standard. Secure-Air-Flow, diamond perforated and louvered door styles are available

**HANDLE:** Deep-drawn seamless stainless steel recessed handle door strike: Continuous vertical door strike at both hinge and latch side

**LATCHING:** Single-point maintenance-free quiet latching system, 11 gauge MIG welded latch

**HINGES:** 16 gauge continuous piano type

**SHELVES:** 16 gauge hat shelf for single tier openings 60" and 72" high, 16 gauge intermediate shelves

**HOOKS:** 2-single hooks and 1-double hook is standard. 1-double hook only for triple tier 1-double and 1-single hook for 9" wide openings 30" and higher

**SIZES:** See page 16 for standard wardrobe locker sizes



## AMP-1006 ATHLETIC BOX LOCKERS

 **LIFETIME WARRANTY**

 **TWIN FRAME ALL-WELDED**

*Art Metal Products all-welded box lockers are the perfect storage solution when space is at a premium.*

Incorporating our new Twin-Frame design with easy to open single-point thru-the-door friction catch/door pull padlock hasps and diamond perforated doors and sides, our welded box lockers will stand the test of time. Our all-welded box lockers are excellent in combination with any of our AMP-1002, AMP-1003, AMP-1004 and AMP-1005 wardrobe lockers providing box door to wardrobe ratios to meet all of your P.E. locker requirements.



Shown with optional Padlock Strike Plates



**CHOOSE FROM UNLIMITED COMBINATIONS TO MEET YOUR SPECIFIC LOCKER NEEDS**

**Widths for all gym locker openings 12", 15", 18"**

**Depths for all gym locker openings 12", 16", 18", 22"**

| TIER                         |            | OPENING HEIGHTS        | NOMINAL COLUMN HEIGHTS  |
|------------------------------|------------|------------------------|-------------------------|
| 4<br>TIER<br>TO<br>9<br>TIER | Four Tier  | 8", 9", 12", 15", 18"  | 32", 36", 48", 60", 72" |
|                              | Five Tier  | 12", (4) 15" & (1) 12" | 60", 72"                |
|                              | Six Tier   | 8", 10", 12"           | 48", 60", 72"           |
|                              | Seven Tier | (6) 10" & (1) 12"      | 72"                     |
|                              | Eight Tier | 8", 9"                 | 64", 72"                |
|                              | Nine Tier  | 8"                     | 72"                     |

# FEATURES & OPTIONS



## AMP-1006 Athletic Box Twin-Frame All-Welded Lockers



### UPGRADE TO AMP-1006E

Elite Series lockers which include a 3" wide 18 gauge full height door stiffener spot welded to the inner door face and MIG welded to the hinge side as well as to the top and bottom door flanges providing a rigid torque-free door. A 1-1/2" wide stiffener will be furnished for 12" wide AMP-1006E Elite Series all-welded box lockers.



**OPTIONAL** deep-drawn 304 stainless steel recessed handle with single-point latching



**OPTIONAL INTEGRAL SLOPE TOP** 16 gauge steel, runs continuous across a multiple column unit and is MIG welded at the factory replacing welded locker unit flat top. Sides are sloped at top providing rigid support beneath the slope top between each locker column.

### STANDARD SINGLE-POINT

thru-the-door finger pull padlock hasp for all box lockers



**OPTIONAL** Padlock Strike Plates for box doors protect finish from being marred by padlock



## AMP-1006 FEATURES

**BODY CONSTRUCTION:** Twin-Frame all-welded construction, 16 gauge 1-1/2" high continuous bottom with reinforcing channels welded to the underside at each side panel providing a rigid unit base. 16 gauge continuous top, 16 gauge diamond perforated sides are integral with front vertical frame, 18 gauge solid back

**DOORS:** 14 gauge diamond perforated doors are standard. Louvered, Secure-Air-Flow and plain door styles are available.

**HANDLE/LATCHING:** Single-point thru-the-door projecting finger pull handle with padlock hasp. Optional deep-drawn seamless stainless steel recessed handle is available

**HINGES:** 16 gauge continuous piano type

**HOOKS:** None

**SHELVES:** 16 gauge intermediate shelves

**SIZES:** See chart page 21 for standard box locker sizes

**NOTE:** 8" and 9" high box doors will be top hinged with a concealed 3/8" diameter continuous hinge rod

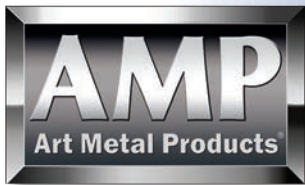

## AMP-1006 ATHLETIC BOX LOCKERS

**QUALITY, DURABILITY AND PRACTICAL STORAGE SOLUTIONS**

**CHOOSE FROM 16 COMBINATIONS TO MEET YOUR EXACT LOCKER NEEDS.**



### AMP COMBINATION P.E. LOCKERS

The design flexibility of our all-welded athletic lockers allows us to mix and match wardrobe lockers with box lockers to meet any configuration and/or ratio your facility may demand. Please contact our [Sales Manager](mailto:Sales Manager) at 1-800-252-5633. We will help you to create an environment that will be both esthetically pleasing and functional.

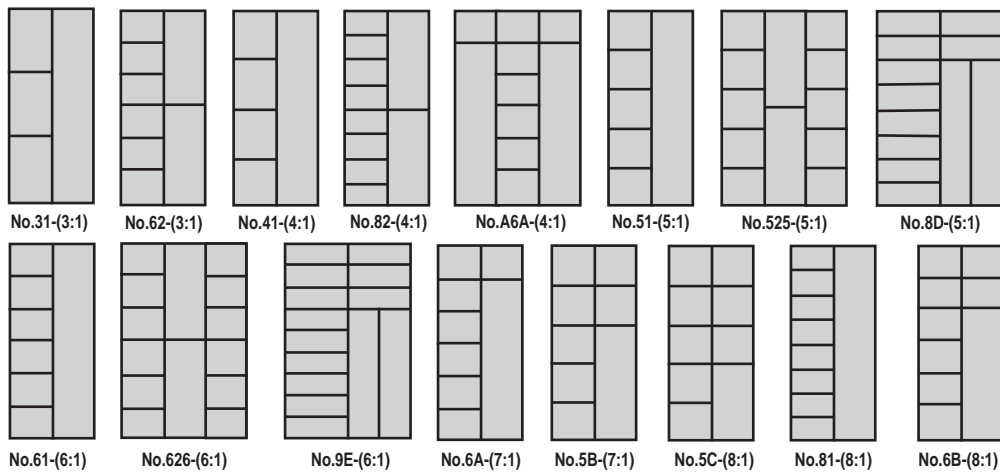



PERFECT FOR SWAT, POLICE, FIRE AND ALL EMERGENCY RESPONSE TEAMS



**LIFETIME WARRANTY**



- ✓ **Utility belt hook**
- ✓ **Security box**
- ✓ **One side pocket shelf for a 1" thick clipboard**
- ✓ **Full height piano hinge**
- ✓ **Finish is standard powder-coat**
- ✓ **Full height door stiffeners**
- ✓ **Lower storage area with pull-out drawer**
- ✓ **Auto-Locking drawer is activated by upper doors**
- ✓ **Electrical Knockout in locker top - outlet and wiring by others**



Standard electrical knockout at locker top right rear corner

**OPTIONS**

- PEGBOARD DOOR STIFFENER
- BOOT TRAY
- BODY ARMOR DRYING RACK
- PERSONAL ITEMS ACCESSORY TRAY
- LOUVERED DRAWER FRONT
- PERFORATED RE-ENFORCED TOP
- AIRFLOW GAP
- SHELVES SPACED AWAY FROM BACK FOR ADDED AIRFLOW

Available with and without base storage compartment and seat

| STANDARD UPPER UNIT SIZES |
|---------------------------|
| Widths: 24", 30", 36"     |
| Depths: 18", 24"          |
| Height: 72"               |

| STANDARD BASE UNIT SIZES |
|--------------------------|
| Widths: 24", 30", 36"    |
| Depths: 30" 36"          |
| Height: 18"              |



**FEATURES**

**BODY CONSTRUCTION:** 16 gauge, Unibody all-welded, sides, galvanneal corrosion resistant sheet steel.

**BACK:** 18 gauge.

**BODY STYLES:** Single tier, custom design for specialized use.

**FEATURES:** Security box (9" x 12") with keyed lock.

**DOOR:** 14 gauge louvered double doors with full-height welded in stiffener.

**HINGES:** Continuous piano type.

**HANDLE:** 3/16" Steel handle with high security 3-point turn handle latching and 3/8" diameter steel locking rods.

**HOOKS:** Two single wall hooks in wardrobe area plus single hook for opening below security box.

**COAT RODS:** One at vertical wardrobe section.

**SHELVES:** Two full-width at top, one partial shelf above security box.

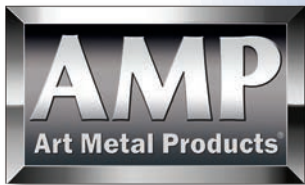

# TURNOUT GEAR FIREFIGHTER LOCKERS

## EMERGENCY RESPONSE ALL-WELDED LOCKERS

 **LIFETIME WARRANTY**



Base model shown with standard perforated base and stainless steel coat rod.



Shown with optional security box and optional foot locker.



Shown with optional ventilated door and metal base.

# TURNOUT GEAR FIREFIGHTER LOCKERS

## EMERGENCY RESPONSE ALL-WELDED LOCKERS



- ✓ Fully-framed, all welded, rugged construction.
- ✓ Maximum ventilation with expanded metal sides.
- ✓ Upper shelf provides storage for helmets and head gear.
- ✓ Without base models include ventilated bottom.
- ✓ Open-front provides quick access to gear and clothing.
- ✓ 721 Relay Red hammertone textured powder coat finish.



Optional Security Box uses Two heavy-duty 13 gauge 7-knuckle 3-1/2" hinges and a finger pull padlock hasp



Models with base are designed to be installed on the floor



Fixed hat shelf and stainless steel coat rod with 2 single prong hooks



Models without base have ventilated bottom plate and are designed to be installed on the wall with the wall mounting angle



### GENERAL SPECIFICATIONS

**BODY CONSTRUCTION:** Fully-framed all-welded construction, 13 gauge 1/2" fully-framed flattened expanded metal sides, 18 gauge solid back, 16 gauge galvanized bottom.

**DOORS (OPTIONAL):** 14 gauge galvanized steel. Security box door is solid. Full-height door is diamond perforated and includes 18 gauge door stiffener.

**HANDLE/LATCHING:** Optional security box has friction catch, finger pull. Optional full-height door has gravity lift-type multi-point spring loaded latching and stainless steel recessed handle. Optional foot locker is prepared for padlocks only.

**HINGES:** Optional doors have heavy-duty 13 gauge 7-knuckle 3 1/2" hinges.

**SHELVES:** Two upper 16 gauge galvanized steel shelves are standard.

**HOOKS/COAT ROD:** Four single prong hooks and stainless steel coat rod are standard.

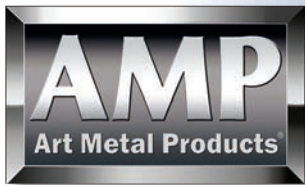

## TA-50 MILITARY GRADE STORAGE LOCKERS



Designed to be the solution to all your storage challenges, the TA-50 Equipment Storage Locker is secure, durable and is guaranteed to last the lifetime of your facility.





# TA-50 MILITARY GRADE STORAGE LOCKERS



## STANDARD



Rugged 3/16" Steel Handle is prepared for use with a padlock. Doors are pre-punched to accommodate a built-in combination or key lock if desired

## STANDARD



Heavy-duty 13 gauge 7-knuckle 3-1/2" butt hinges. Handle: 3-point turn-handle latching with 3/8" diameter locking rods for maximum security



## TA-50 GEAR LOCKER AVAILABLE SIZES

**Widths:** 36-1/2", 42-3/8", 48-1/4"

**Depths:** 18", 22", 24"

**Heights:** 74-3/4", 78", 84"

## FEATURES

**BODY CONSTRUCTION:** Fully-framed all-welded construction, 13 gauge 1/2" fully-framed flattened expanded metal sides, 16 gauge top, 18 gauge solid back and 16 gauge galvanized bottom. Optional solid sides are available.

**DOORS:** 14 gauge diamond perforated doors with 18 gauge full-height door stiffener for both doors is standard. Louvered, Secure-Air-Flow and plain door styles are available

**HANDLE:** 3-point turn-handle latching

**SHELVES:** 16 gauge galvanized upper shelf located 12" down from top, 16 gauge galvanized lower shelf located 18" up from bottom and 16 gauge galvanized bottom shelf

**DOOR HINGES:** Heavy-duty 13 gauge 7-knuckle 3-1/2" hinges

**ACCESSORIES:** Stainless steel coat rod located under upper shelf.



# UNIBODY ALL-WELDED SCHOOL CUBBIES

# CUBBIE™

**CHILDREN SAFE!**

The Art Metal Products Cubbie Locker line is designed to meet the needs of early childhood and elementary school classrooms. Combining our unibody all-welded locker construction and the added safety features required for this

specialized market, we offer four distinct models designed to meet any child's personal storage needs. AMP Cubbies are backed by our written lifetime Warranty.

## ROUNDED CORNERS AND HEMMED EDGES!



### CORROSION RESISTANT BOTTOM

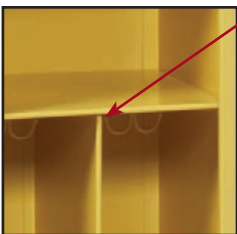

Hemmed and beaded edges eliminate sharp edges

Number plate in bottom of cubbie so children can easily identify their cubbie space.





**ROUNDED CORNERS AND HEMMED EDGES!**



**4 MODELS & 24 COLORS**



Primary Cubbie      Primary II Cubbie      Primary Jr. Cubbie      Backpack Cubbie



| MODEL SIZES        | WIDTH    | DEPTH    | HEIGHT |
|--------------------|----------|----------|--------|
| Primary Cubbie     | 12", 15" | 12", 16" | 48"    |
| Primary II Cubbie  | 12", 15" | 12", 16" | 48"    |
| Primary Jr. Cubbie | 12", 15" | 12", 16" | 24"    |
| Backpack Cubbie    | 15", 18" | 12", 16" | 48"    |

**FEATURES**

**BODY CONSTRUCTION:** Unibody all-welded 16 gauge steel construction, backs are 18 gauge, bottom is galvanneal sheet steel for maximum corrosion resistance, hemmed and beaded edges are safe to the touch.

**BODY STYLES:** Open design, 4 body styles.

**SHELVES:** 16 gauge welded to body for added rigidity with a beaded leading edge for added safety.

**NOTES:** Easily secures to wall and floor for added safety, low installation costs, reduced installation time, low maintenance, low life-cycle cost, lifetime warranty, insect and termite proof. All welded cubbies will ship in multiple column units up to 60" wide to meet individual jobsite conditions.





# STANDARD KD WARDROBE LOCKERS

**2 YEAR WARRANTY**



## STANDARD



Deep-drawn 304 stainless steel recessed handle with multi-point gravity lift-type latching

## STANDARD



12 gauge latch hook is welded to frame

## STANDARD



16 gauge continuous piano hinge

**SINGLE TIER**  
Provides ample height for hanging of full length garments.

**DOUBLE TIER**  
Where full length hanging of garments is not required double tier lockers offer an economical alternative.

**TRIPLE TIER**  
Triple tier lockers are ideal for use where storage of long garments is not required.



**MAX UPGRADE** all body components to 16 gauge with 18 gauge back. Recommended when placing heavy items in lockers such as backpacks.



**GREENGUARD GOLD CERTIFIED**

## STANDARD KD WARDROBE LOCKER SIZES

| TIER        | WIDTH              | DEPTH               | OPENING HEIGHT  | FRAME HEIGHT    |
|-------------|--------------------|---------------------|-----------------|-----------------|
| SINGLE TIER | 9" 12" 15" 18" 24" | 12" 15" 18" 21" 24" | 36" 48" 60" 72" | 36" 48" 60" 72" |
| DOUBLE TIER | 9" 12" 15" 18"     | 12" 15" 18" 21" 24" | 30" 36"         | 60" 72"         |
| TRIPLE TIER | 9" 12" 15"         | 12" 15" 18" 21" 24" | 20" 24"         | 60" 72"         |

## FEATURES

**BODY CONSTRUCTION:** Knock down (KD) with 24 gauge solid body components

**DOORS:** 16 gauge louvered doors, 18 gauge for 9" wide are standard. Secure-Air-Flow, Safety-View and diamond perforated door styles are available. See Standard Quiet lockers on page 38 for plain door option

**LATCHING:** 12 gauge latch hooks MIG welded to frame. Gravity lift-type multi-point spring loaded latching:

- 3-point latching for openings 48" high and higher
- 2-point latching for openings 20" high thru 36" high

Lock Bars are fabricated from G90 galvanized steel and are installed into the door after paint.

**FRAME:** 16 gauge frame with 16 gauge horizontal cross member between doors on double and triple tier wardrobe lockers

**DOOR STRIKE:** Continuous vertical door strike at both hinge and latch side

**HOOKS:** 2-single hooks and 1-double hook is standard.  
1- double hook only for triple tier and 1-double and 1 - single hook for 9" wide openings 30" and higher

**SHELVES:** Hat shelf for single tier openings 60" and 72" high

**NOTES:** All production KD lockers are supplied without legs unless otherwise specified

# STANDARD KD BOX LOCKERS

**2** YEAR WARRANTY



### STANDARD



Box door single-point thru-the-door finger pull padlock hasp (shown with optional Padlock Strike Plate)

### STANDARD



16 gauge continuous piano hinge



**OPTION**  
**STRIKE PLATE**  
Padlock Strike Plates for box doors protect finish from being marred by padlock

**MAX**  
**OPTION**  
**UPGRADE** all body components to 16 gauge with 18 gauge back. Recommended when placing heavy items in lockers such as backpacks.

| STANDARD KD BOX LOCKER SIZES |         |             |                |              |
|------------------------------|---------|-------------|----------------|--------------|
| TIER                         | WIDTH   | DEPTH       | OPENING HEIGHT | FRAME HEIGHT |
| FOUR TIER                    | 12" 15" | 12" 15" 18" | 15" 18"        | 60" 72"      |
| FIVE TIER                    | 12" 15" | 12" 15" 18" | 12" 14.4"      | 60" 72"      |
| SIX TIER                     | 12" 15" | 12" 15" 18" | 12"            | 72"          |



## FEATURES

**BODY CONSTRUCTION:** Knock down (KD) with 24 gauge solid body components

**DOORS:** 18 gauge louvered doors are standard. Plain, Secure-Air-Flow and diamond perforated door styles are available

**FRAME:** 16 gauge frame

**HANDLE:** Projecting finger pull

**DOOR STRIKE:** Continuous vertical door strike at both hinge and latch side

**LATCHING:** Single-point thru-the-door finger pull padlock hasp

**HINGES:** 16 gauge continuous piano type

**NOTES:** All production KD lockers are supplied without legs unless otherwise specified.

**HOOKS:** None



# STANDARD KD SPECIALTY LOCKERS

**2 YEAR WARRANTY**

**When you need an economical multi-purpose, practical and space-saving locker solution.**



### FOUR-WIDE WALL MOUNT

Wall mount Lockers provide ample additional storage space for 4 persons. Wall mount lockers can be used as supplemental storage in combination with other lockers or in specific applications where floor space is limited and storage requirements must be met. 48" wide under-mount coat rod is optional.



### STANDARD



16 gauge continuous piano hinge

### STANDARD



**BOX FINGER PULL**  
Box door single-point thru-the-door finger pull padlock hasp (shown with optional Padlock Strike Plate)



*Optional Padlock Strike Plates for box doors protect finish from being marred by padlock*

### SIXTEEN-PERSON

An economical solution for personal security along and hanging space for full length garments. Ideal for student and teacher lounges, offices, commercial and retail establishments. Sixteen-Person lockers come with standard 6" high legs; 48" coat rod included

**MAX OPTION UPGRADE** all body components to 16 gauge with 18 gauge back. Recommended when placing heavy items in lockers such as backpacks.

| STANDARD KD SPECIALTY LOCKER SIZES |          |                    |                |                    |
|------------------------------------|----------|--------------------|----------------|--------------------|
| MODEL                              | WIDTH    | DEPTH              | OPENING HEIGHT | FRAME HEIGHT       |
| Two-Person                         | 15", 18" | 12", 15", 18", 21" | N/A            | 60", 72"           |
| Duplex                             | 15"      | 12", 15", 18", 21" | 60", 72"       | 60", 72"           |
| Sixteen-Person                     | 72"      | 18"                | 12"            | 78" (with 6" legs) |
| 4-Wide Wall Mount                  | 48"      | 18"                | 12"            | 14-3/4"            |

# STANDARD KD SPECIALTY LOCKERS



## Duplex & Two Person Lockers

**2 YEAR WARRANTY**



### DUPLEX

The most economical full length locker available, it conserves valuable floor space, yet provides ample height for hanging full length garments. Duplex lockers provide two completely private lockers in each frame. One hat shelf and two single hooks are standard in each wardrobe opening. Coat rods are optional for 18" and deeper models.



### STANDARD

Upper box door of Two-Person locker is opened from within user's wardrobe compartment

### TWO-PERSON

Two-Person lockers provide ample storage space for two users in a 15" or 18" wide space. Upper box doors are controlled by command latches located in the corresponding lower compartment. Two single hooks per wardrobe opening are standard. Coat rods are optional for 18" and deeper.

### STANDARD FOR WARDROBE DOORS

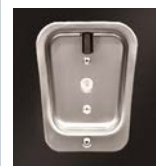

Deep-drawn 304 stainless steel recessed handle with multi-point gravity lift-type latching

### STANDARD



12 gauge latch hook is welded to frame

### STANDARD FOR BOX DOOR



16 gauge continuous piano hinge



## FEATURES

**BODY CONSTRUCTION:** Knock down (KD) with 24 gauge solid body components.

**DOORS:** 16 gauge louvered doors, 18 gauge for 9" wide are standard. Secure-Air-Flow, Safety-View and diamond perforated door styles are available.

**LATCHING:** 12 gauge latch hooks MIG welded to frame. Gravity lift-type multi-point spring loaded latching:

- 3-point latching for openings 48" high and higher
- 2-point latching for openings 20" high thru 36" high

Lock Bars are fabricated from G90 galvanized steel and are installed into

the door after paint.

**FRAME:** 16 gauge frame with 16 gauge horizontal cross member between doors on double and triple tier wardrobe lockers.

**DOOR STRIKE:** Continuous vertical door strike at both hinge and latch side.

**HOOKS:** 2-single hooks and 1-double hook is standard.

- 1- double hook only for triple tier 1-double
- 1-double & 1- single hook for 9" wide openings 30" and higher .

**SHELVES:** Hat shelf for single tier openings 60" and 72" high

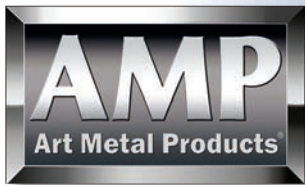

# STANDARD QUIET & ARTISAN QUIET KD LOCKERS

## 2 YEAR WARRANTY



### STANDARD QUIET

Lockers are constructed just like our Standard K.D. lockers, except the door is furnished without louvers to limit air rush through the door, providing quiet operation. Perforations on upper and lower door flanges allow concealed ventilation.



### DOOR FEATURES

Perforated top and bottom door flanges for all Standard Quiet and Whisper Quiet lockers allow for concealed ventilation



### ARTISAN QUIET

The die-formed sound deadening panel filled with acoustical material provide the quietest and most aesthetically appealing gravity latch locker.

*UPGRADE to Artisan Quiet which adds a quiet latching mechanism and an acoustically filled sound deadening panel welded to the interior of the door face to further reduce decibel levels.*

Double Tier  
1-Wide

### STANDARD



Deep-drawn 304 stainless steel recessed handle with multi-point gravity lift-type latching

### STANDARD



12 gauge latch hook is welded to frame

### STANDARD



16 gauge continuous piano hinge

**MAX OPTION** **UPGRADES** all body components to 16 gauge with 18 gauge back. Recommended when placing heavy items in lockers such as backpacks.



## FEATURES

**BODY CONSTRUCTION:** Knock down (KD) 24 gauge solid body components

**DOORS:** 16 gauge plain doors (18 gauge for 9" wide), sound deadening panel for Artisan Quiet lockers only

**FRAME:** 16 gauge frame with 16 gauge horizontal cross member between doors on double and triple tier wardrobe lockers

**HANDLE:** Deep-drawn stainless steel recessed handle

**DOOR STRIKE:** Continuous vertical door strike at both hinge and latch side

**HINGES:** 16 gauge continuous piano type

**LATCHING:** 12 gauge latch hooks MIG welded to frame. Gravity lift-type multi-point spring loaded latching:

- 3-point latching for openings 48" high and higher
- 2-point latching for openings 20" high thru 36" high
- Isolated latching mechanism for Whisper Quiet only

Lock Bars are fabricated from G90 galvanized steel and are installed into the door after paint.

**HOOKS:** 2-single hooks and 1-double hook is standard. 1- double hook only for triple tier and 1-double and 1 - single hook for 9" wide openings 30" and higher

**SHELVES:** Hat shelf for single tier openings 60" and 72" high

**NOTES:** All production KD lockers are supplied without legs unless otherwise specified. Standard Quiet and Artisan Quiet lockers are available with plain doors only. Additional perforations/louvers in the door will increase decibel levels thus reducing the efficiency of our quiet design



# HEAVY-DUTY CORRIDOR (HDC) KD LOCKERS



**HEAVY-DUTY CORRIDOR** lockers, commonly known as HDC lockers, are designed to include all the great features of our Standard KD wardrobe lockers; however, the door gauge is increased to 14 gauge which is 25% heavier than standard 16 gauge doors. To further increase door integrity, we offer our HDC Elite model which includes an 18 gauge full height door stiffener.



Single Tier  
1-Wide

Double Tier  
1-Wide

Triple Tier  
1-Wide



*Upgrade to Elite Series HDC lockers which include a 3" wide 18 gauge full height door stiffener. A 1-1/2" wide stiffener will be furnished for 9" wide Elite doors.*

## STANDARD



Deep-drawn 304 stainless steel recessed handle with multi-point gravity lift-type latching

## STANDARD



12 gauge latch hook is welded to frame

## STANDARD



16 gauge continuous piano hinge

**MAX UPGRADES** all body components to 16 gauge with 18 gauge back. Recommended when placing heavy items in lockers such as backpacks.



## FEATURES

**BODY CONSTRUCTION:** Knock down (KD) with 24 gauge solid body components

**DOORS:** 14 gauge louvered doors are standard. Plain, Secure-Air-Flow, Safety-View and diamond perforated door styles are available

**FRAME:** 16 gauge frame with 16 gauge horizontal cross member between doors on double and triple tier wardrobe lockers

**HANDLE:** Deep-drawn seamless stainless steel recessed handle

**DOOR STRIKE:** Continuous vertical door strike at both hinge and latch side

**HINGES:** 16 gauge continuous piano type

**LATCHING:** 12 gauge latch hooks MIG welded to frame. Gravity lift-type multi-point spring loaded latching:

- 3-point latching for openings 48" high and higher
- 2-point latching for openings 20" high thru 36" high

Lock Bars are fabricated from G90 galvanized steel and are installed into the door after paint.

**HOOKS:** 2-single hooks and 1-double hook is standard. 1- double hook only for triple tier and 1-double and 1 - single hook for 9" wide openings 30" and higher

**SHELVES:** Hat shelf for single tier openings 60" and 72" high



# MAGNUM™ STUDENT KD LOCKERS

## 2 YEAR WARRANTY

The Magnum Student K.D. single-point (no moving parts latching mechanism) corridor locker is by far our quietest K.D. locker ever and an economical alternative to our top of the line all-welded AMP-1005 Bulldog locker.



### STANDARD



Deep-drawn 304 stainless steel recessed handle with single-point latching

### STANDARD



16 gauge continuous piano hinge

### STANDARD



11 gauge single-point latch MIG welded to frame

### STANDARD



Includes a 3" wide 18 gauge full height door stiffener, spot welded to the inner door face and MIG welded to the hinge side as well as to the top and bottom door flanges providing a rigid torque-free door. A 1-1/2" wide stiffener will be furnished for 9" wide Magnum doors.

**MAX** **UPGRADES** all body components to 16 gauge with 18 gauge back. Recommended when placing heavy items in lockers such as backpacks.

**OPTION**



### UPGRADE

#### MAGNUM DOOR LINER

18 gauge full width door liner covers back of recessed handle. Built-in lock attaches to both door liner and recessed handle for maximum security and rigidity.



## FEATURES

**BODY CONSTRUCTION:** Knock down (KD) with 24 gauge solid body components

**DOORS:** 14 gauge plain doors with 18 gauge full-height door stiffener are standard. Louvered, Secure-Air-Flow and diamond perforated door styles are available

**FRAME:** 16 gauge frame with 16 gauge horizontal cross member between doors on double and triple tier wardrobe lockers

**HANDLE:** Deep-drawn seamless stainless steel recessed handle

**DOOR STRIKE:** Continuous vertical door strike at both hinge and latch side

**LATCHING:** Single-point maintenance-free quiet, 11 gauge latch hooks MIG welded to frame

**HINGES:** 16 gauge continuous piano type is standard. Heavy-duty 13 gauge 3-1/2" 7-knuckle hinges are available as an upgrade

**HOOKS:** 2-single hooks and 1-double hook is standard.

- 1- double hook only for triple tier 1-double
- 1-double & 1- single hook for 9" wide openings 30" and higher

**SHELVES:** Hat shelf for single tier openings 60" and 72" high

**NOTES:** All production KD lockers are supplied without legs unless otherwise specified.

# HEAVY-DUTY VENTILATED (HDV) KD LOCKERS



**2 YEAR WARRANTY**

HDV Lockers are the perfect choice and offer exceptional value. When budget limitations do not allow for all-welded athletic lockers, Heavy-Duty Ventilated "HDV" lockers are the perfect alternative.

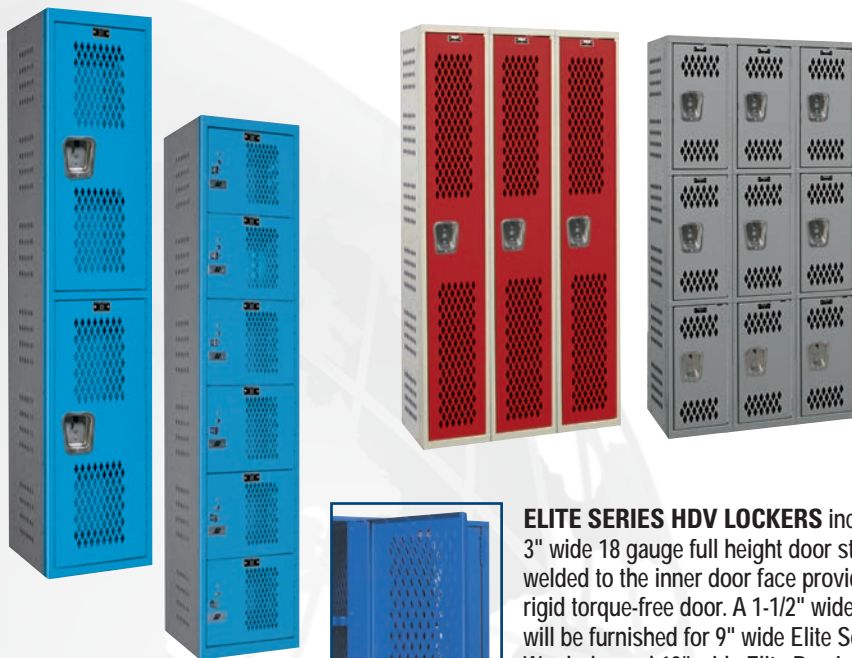

Double Tier 1-Wide

Six Tier 1-Wide



**ELITE SERIES HDV LOCKERS** include our 3" wide 18 gauge full height door stiffener welded to the inner door face providing a rigid torque-free door. A 1-1/2" wide stiffener will be furnished for 9" wide Elite Series Wardrobe and 12" wide Elite Box Locker doors.

**MAGNUM STUDENT SERIES HDV LOCKERS** which include our deep-drawn seamless stainless steel recessed handle with single-point latching, and a 3" wide 18 gauge full height door stiffener spot welded to the inner door face and MIG welded to the hinge side as well as to the top and bottom door flanges providing a rigid torque-free door. A 1-1/2" wide stiffener will be furnished for 9" wide Magnum Series doors.



**STANDARD FOR WARDROBE DOORS**



Deep-drawn 304 stainless steel recessed handle with multi-point gravity lift-type latching

**STANDARD**



12 gauge latch hook is welded to frame

**STANDARD**



16 gauge continuous piano hinge

**STANDARD FOR BOX DOORS**



Single-point thru-the-door finger pull padlock hasp is standard for HDV box doors 18" high and under



**FEATURES**

**BODY CONSTRUCTION:** (Wardrobe & Box lockers): Knock down (KD) with 16 gauge solid top, bottom and intermediate shelves, 16 gauge diamond perforated sides, 18 gauge solid back

**DOORS:** 14 gauge diamond perforated doors are standard. Louvered, Secure-Air-Flow and plain door styles are available

**FRAME:** 16 gauge frame with 16 gauge horizontal cross member between doors on double and triple tier wardrobe lockers

**HANDLE:** Wardrobe Lockers (doors 20" and higher) - Deep-drawn seamless stainless steel recessed handle, Box lockers - Single-point thru-the-door finger pull padlock hasp

**HINGES:** 16 gauge continuous piano type

**DOOR STRIKE:** Continuous vertical door strike at both hinge and latch side

**LATCHING:** Gravity lift-type multi-point spring loaded latching:

- 3-point latching for openings 48" high and higher,
- 2 point latching for openings 20" high thru 36" high

Lock Bars are fabricated from G90 galvanized steel and are installed into the door after paint.

**HOOKS:** 2-single hooks and 1-double hook is standard.

- 1- double hook only for triple tier 1-double
- 1-double & 1- single hook for 9" wide openings 30" and higher
- Box lockers no hooks

**SHELVES:** 16 gauge hat shelf for single tier openings 60" and 72" high

**NOTES:** All production KD lockers are supplied without legs unless otherwise specified



## SAFETY-VIEW™ LOCKERS

**2** YEAR WARRANTY

**SAFETY VIEW™**



Double Tier lockers  
(Also available in single and triple tier)

The perfect solution when close monitoring of locker contents is desired.

### STANDARD



Deep-drawn 304 stainless steel recessed handle with multi-point gravity lift-type latching

### STANDARD



12 gauge latch hook is welded to frame

### STANDARD



16 gauge continuous piano hinge



### FEATURES

**BODY CONSTRUCTION:** Knock-down, 24 gauge,

**SPECIAL FEATURES:** Wardrobe: Two, high strength injection molded polycarbonate panels per door for content viewing Box: High strength injection molded polycarbonate doors for content viewing

**DOOR:** 16 gauge (For wardrobe doors only)

**HINGES:** Continuous piano type

**HANDLE:** (wardrobe): Stainless steel recessed handle with multi-point gravity lift-type latching. Recessed handle protects finish from being marred by padlock. Single-point projecting friction catch door pull prepared for both padlock or built-in lock is standard for box doors

**HOOKS:** One double prong ceiling hook and two single hooks per single and double tier opening. One double ceiling hook for triple tier.

**COAT RODS:** Available for single tier at a nominal cost.

**SHELVES:** Hat shelf is included in 60" and 72" high single tier lockers. notes: Meets UL flammability standards, Polycarbonate is approved by the Consumer Product Safety Commission (CPSC16CFR 1201). All production lockers are standard with no legs unless otherwise specified. Safety-View doors are available as a retrofit to most lockers.

**NOTES:** Meets UL flammability standards, Polycarbonate is approved by the Consumer Product Safety Commission (CPSC16CFR 1201). All production lockers are standard with no legs unless otherwise specified. Safety-View doors are available as a retrofit to most lockers.

**SAFETY-VIEW™ PLUS LOCKERS**

**SAFETY  
VIEW™  
PLUS**



See-thru doors



Sixteen-Person lockers  
(6" high legs are standard)  
Shown with optional closed metal base



4-wide wall mount lockers



Four and Six Tier Lockers  
(also available in five tier)

**STANDARD**



Box door single-point thru-the-door finger pull padlock hasp

**STANDARD**



16 gauge continuous piano hinge



| STANDARD SAFETY-VIEW & SAFETY VIEW PLUS LOCKER SIZES |                   |               |               |                |                  |
|--|-------------------|---------------|---------------|----------------|------------------|
|  | MODEL             | OPENING WIDTH | OPENING DEPTH | OPENING HEIGHT | FRAME HEIGHT     |
| Safety-View Lockers                                  | Single Tier       | 12"           | 12", 15", 18" | 60", 72"       | 72"              |
|  | Double Tier       | 12"           | 12", 15", 18" | 30", 36"       | 72"              |
|  | Triple Tier       | 12"           | 12", 15", 18" | 20", 24"       | 72"              |
| Safety-View Plus Lockers                             | Four Tier         | 12"           | 12", 15", 18" | 18"            | 72"              |
|  | Five Tier         | 12"           | 12", 15", 18" | 12"            | 60"              |
|  | Six Tier          | 12"           | 12", 15", 18" | 12"            | 72"              |
|  | Sixteen-Person    | 12"           | 18"           | 12"            | 78" with 6" legs |
|  | 4-Wide Wall Mount | 12"           | 18"           | 12"            | 14-3/4"          |



# 304 STAINLESS STEEL LOCKERS

ATTRACTIVE DURABLE RUST RESISTANT **2 YEAR WARRANTY**

## 304 Stainless Steel

The rich appearance and durable surface of 304 Stainless Steel Lockers make them the perfect locker solution for areas prone to rust and sanitation concerns and are ideal for food industry, pool area and outdoor.



Single Tier  
1-Wide

Double Tier  
1-Wide

Shown with  
optional 6"  
legs  
Triple Tier  
1-Wide

### STANDARD FOR WARDROBE DOORS



Deep-drawn 304 stainless steel recessed handle with multi-point gravity lift-type latching

### STANDARD



12 gauge latch hook is welded to frame

### STANDARD FOR BOX DOOR



Single-point thru-the-door finger pull padlock hasp is standard for HDV box doors 18" high and under

### GENERAL SPECIFICATIONS

**BODY CONSTRUCTION:** Knock down (KD) with 24 gauge 304 stainless steel body components

**DOORS:** 16 gauge 304 stainless steel louvered doors are standard.

**FRAME:** 16 gauge 304 stainless steel frame with 16 gauge horizontal cross member between doors on double tier wardrobe lockers

**HANDLE:** Wardrobe doors have a deep-drawn seamless 304 stainless steel recessed handle. Box doors the projecting finger-pull handle is standard

**DOOR STRIKE:** Continuous vertical door strike at both hinge and latch side

**LATCHING (WARDROBE):** 12 gauge latch hooks MIG welded to frame. Gravity lift-type multi-point spring loaded latching:

- 3-point latching for openings 48" high and higher
- 2-point latching for openings 20" high thru 36" high

**LATCHING (BOX):** Single-point thru-the-door finger pull padlock hasp

**HINGES:** 2" long 16 gauge 5-knuckle stainless steel hinges. 3 hinges for doors 48" and higher and 2 for doors under 48" high.

**HOOKS:** 2-single hooks and 1-double hook is standard. 1- double hook only for triple tier and 1-double and 1 - single hook for 9" wide openings 30" and higher. No hooks in openings less than 20" high.

**SHELVES:** Hat shelf for single tier openings 60" and 72" high

**NOTES:** All production KD lockers are supplied without legs unless otherwise specified



# AMP LOCKER ACCESSORIES

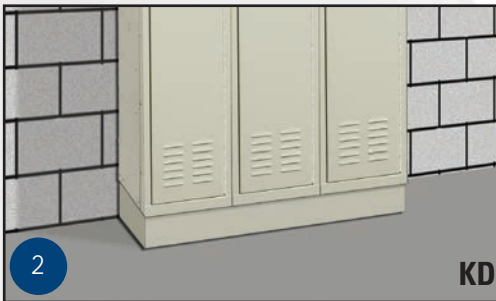

## SPECIFICATIONS

**1 - 6" Closed Front Base (KD lockers only):** Shall be fabricated of 16 gauge cold rolled sheet steel flanged on all four sides for rigidity. Front bases include projecting tabs on side flanges designed to align with holes in front legs allowing front bases to be snapped into place requiring no additional fasteners. Side bases are to be included at all exposed ends and are bolted to front and rear legs. Finish to match lockers.

**2 - 4" Continuous Z-Base (KD lockers only):** Shall be fabricated from 16 gauge cold rolled sheet steel fabricated in 72" lengths, flanged at the top to form a 1-3/8" toe space and at the bottom allowing concealed fastening to the finished floor. Continuous Front Bases include holes for use with splice plates where bases are joined end-to-end. End Bases are to be included at all exposed ends. Where additional support is desired, End Bases may be substituted for splices at Continuous Front Base joints. Finish to match lockers.

**3 - 20 gauge Individual Slope Top (KD lockers only):** Not less than 20 gauge cold rolled sheet steel, 18 degree pitch, fabricated to be installed individually over each locker. Slope top is formed to include a full back. Individual Slope Tops are to be installed in addition to the locker flat top. End closures are to be provided at exposed ends. Finish to match lockers.

**4 - 18 gauge Continuous Slope Top:** Not less than 18 gauge cold rolled sheet steel, 18 degree pitch, in 72" lengths. A splice cover with concealed spring clip is to be used to cover joints where Continuous Slope Tops are joined end-to-end. To be installed in addition to the locker flat top with end closures for support. Finish to match lockers.

**4 - 16 Gauge Continuous Slope Top:** Not less than 16 gauge cold rolled sheet steel, 18 degree pitch, in 72" lengths. A splice cover with concealed spring clip is to be used to cover joints where Continuous Slope Tops are joined end-to-end. To be installed in addition to the locker flat top with end closures for support. Finish to match lockers.

**5 - Recessed Trim:** Fabricated of 16 gauge cold rolled sheet steel. 3" wide side trim shall be notched at the top and include a retainer to allow the 3" wide top trim to fit snugly into the side trim. Recess trim is designed to be used when the lockers are installed with the locker fronts flush with the top and side walls. The top and side trim will project 3/8" beyond the side and top walls and include return bends back to the walls. Finish to match lockers.

**6 - Minimum Punched End Panel (KD lockers only):** Shall be from 18 gauge cold rolled steel and formed to fit tightly over the universal side panel at exposed row ends. Holes are provided at perimeter for fastening to locker. Minimum Punched End Panels are designed to cover all fasteners other than those at the perimeter of the panel. Finish to match lockers. Provide at all exposed ends.

**7 - Boxed End Panel:** Shall be "Boxed" type formed from 16 gauge cold rolled steel with 1" O.D. double bends on sides and a single bend at top and bottom with no exposed holes or bolts. If lockers have slope tops, end panels must be formed with slope at top to cover the ends of the slope tops. Finish to match lockers. Provide at all exposed ends.

**8 - Fillers:** Provide where indicated, of not less than 16 gauge cold rolled sheet steel, factory fabricated and finished to match lockers.





# LOCKER BENCHES & PEDESTALS

## PEDESTALS



**4805 HEAVY DUTY STEEL PEDESTAL**  
 Fabricated from 14 guage tube steel with 11 guage formed flanges.  
**Color: TAN**

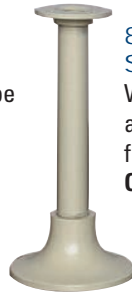

**8032 ADJUSTABLE STEEL PEDESTAL**  
 With cast aluminum base and concealed anchoring to floor.  
**Color: TAN**



**4810 EXTRA HEAVY-DUTY CAST IRON PEDESTAL**  
 With 6" diameter top and bottom flanges with three anchoring holes.  
**Color: TAN**



**4820 ALUMINUM MOVEABLE PEDESTAL**  
 Includes holes for optional permanent anchoring to floor. **Color: TAN**



**4825 STAINLESS STEEL PEDESTAL**  
 Fabricated from 16 guage stainless steel. Designed for moveable and fixed use.  
**Color: Unpainted**

## BENCHES

### WHITE NORTHERN HARD WOOD

Locker Benches are 9-1/2" wide x 1-1/4" thick, made from laminated white northern hard wood, and finished with one coat, deep-penetrating hot sealer, and two coats of heavy body, high-impact, hot, hydraulically applied lacquer. Bench tops are standard in one foot increments from 3' thru 12'. Non-standard lengths are available on special order (pedestal requirement will be for next standard size up).

|                           |         |          |
|---------------------------|---------|----------|
| <b>BENCH TOP LENGTH</b>   | 3' - 8' | 9' - 12' |
| <b>PEDESTALS REQUIRED</b> | 2       | 3        |

Note: Bench top lengths over 12' will be supplied in sections



**SHOWN WITH 4820 PEDESTALS**

### PHENOLIC

Locker Benches are 9-1/2" x 3/4" Thick, made from Wilsonart® phenolic in choice of 18 standard colors. See page 85 for color choices. Available in 1 foot increments from 3' to 10'.

|                           |         |         |          |
|---------------------------|---------|---------|----------|
| <b>BENCH TOP LENGTH</b>   | 3' - 5' | 6' - 8' | 9' - 10' |
| <b>PEDESTALS REQUIRED</b> | 2       | 3       | 4        |

Pedestal space not to exceed 40" O.C.



**SHOWN WITH 4810 PEDESTALS**







# PADLOCKS, BUILT-IN LOCKS & SPECIALTY LOCKS

**AMP recommends MASTER® locks for use on all AMP Lockers.**



**Master Lock Co.  
Built-In Combination Locks**

Available in spring-bolt and dead-bolt styles, are key controlled and include multiple combination settings.

ADA Compliant Version Available



**Master Lock Co.  
Combination Padlocks**

Available standard and master-keyed, Master Lock padlocks can be used on all locker types.

ADA Compliant Padlocks Available



**Master Lock Co.  
Built-In Key Locks**

Available in spring-bolt and dead-bolt styles - Available in standard or master-keyed.

ADA Compliant Version Available



**Hallowell  
DIGITECH™ Locks**

Digitech™ electronic access locks can be programmed for shared or permanent use

ADA Compliant



**SAFE-O-MAT® Built-In  
Coin, Token & Card Locks**

Available in coin return and coin collect as well as token collect and card access styles.



**Hallowell  
DIGITECH™ II RFID Locks**

Digitech RFID electronic access locks can be programmed to work with most current RFID systems

ADA Compliant



**Hallowell  
DIGITECH™ GL Locks**

Digitech™ GL electronic locks are compatible with all AMP gravity lift-type latching lockers. Lock fits nicely in our recessed handle

ADA Compliant

NOTE: An ADA compliant lock must be used on any locker that is required to meet ADA guidelines.

## DOOR VENTILATION OPTIONS



Plain Doors  
(Quiet)



Louvered Doors  
(Classic)



Louvered Doors  
(With Door Stiffener)



Diamond Perforated  
Doors  
(High Ventilation)



Diamond Perforated  
Doors  
(With Door Stiffener)



Secure-Air-Flow Doors  
(Mini Louvers)



Safety-View Doors  
(See-thru Polycarbonate Insert)



Safety-View Plus Box Doors  
(See-thru Polycarbonate Door)  
12" wide x 12" high and  
12" wide x 18" high  
KD box doors only



Hybrid Red Oak Plain  
Door



Hybrid Red Oak Panel  
Door

**QUICKSHIP**

# MODULAR CUBIX LOCKERS



# CUBIX

Stack Cubix lockers and easily attach adjacent units with pre-punched holes on top, sides and bottom. Or use the keyhole punched back for wall mounting. Ships Knock-Down ready-to-assemble,

- 3 Door types to choose from
- 3 Color choices
- 2 Handle/Lock choices

**2 YEAR WARRANTY**



Safety-View Door with Key Cam Lock



Ventilated Diamond Perforated Locker Door



Plain Locker Door with Finger Pull Prepared for Padlock

| Description                                | Overall Width | Overall Height | Overall Depth | Catalog No.     | Color Selection |
|--|---------------|----------------|---------------|-----------------|-----------------|
| <b>PREPARED FOR PADLOCK (NOT INCLUDED)</b> |               |                |               |                 |                 |
| Ventilated Door                            | 11-5/16       | 12-11/16       | 12            | HC121212-1DP    | MB, ME, PL      |
| Solid Door                                 | 11-5/16       | 12-11/16       | 12            | HC121212-1PL    | MB, ME, PL      |
| Safety-View Plus Door                      | 11-5/16       | 12-11/16       | 12            | HC121212-1SVP   | MB, ME, PL      |
| <b>WITH BUILT-IN KEY LOCK (INCLUDED)</b>   |               |                |               |                 |                 |
| Ventilated Door                            | 11-5/16       | 12-11/16       | 12            | HC121212-1DP-K  | MB, ME, PL      |
| Solid Door                                 | 11-5/16       | 12-11/16       | 12            | HC121212-1PL-K  | MB, ME, PL      |
| Safety-View Plus Door                      | 11-5/16       | 12-11/16       | 12            | HC121212-1SVP-K | MB, ME, PL      |



708 BLACK (ME)

707 MARINE BLUE (MB)

711 LIGHT GRAY (PL)

## GENERAL SPECIFICATIONS

**BODY CONSTRUCTION:** Knock-down, 16 gauge

**HINGES:** 16 gauge continuous piano hinge

**DOORS:** 18 gauge Solid (non-vented), Diamond Perforated, or Safety-View (clear)

**HANDLE/LOCKS:** Finger pull latch prepared for padlock (sold separately), or Built-in key lock

**HOOKS:** None

**COAT RODS:** None

**SHELVES:** None

**LEGS:** None





**QUICKSHIP**

## BACKPACK / LAPTOP LOCKERS



4-Tier  
1-Wide  
4 Openings



3-Tier  
1-Wide  
3 Openings

### SPECIAL FEATURES:

- Each locker has built-in channel for concealed after-market wiring to convert lockers to charging stations.
- Channel shall include punch outs for electrical outlet in each opening. Wiring and outlets by others.

**POWERED:** Each locker has built-in channel for concealed after-market wiring to convert lockers to charging stations.

**VENTILATED:** Diamond perforated locker sides promote continuous air flow to cool chargers and components while keeping your items secure.

**LOCK:** Built-in Electronic Access DigiTech H1 lock also acts as locker handle



**2 YEAR WARRANTY**

### BACKPACK / LAPTOP LOCKERS

| WIDTH         | DEPTH | HEIGHT | GROUPING | OPENINGS | UNASSEMBLED CAT NO. | ASSEMBLED CAT NO. | COLOR SELECTION |
|---------------|-------|--------|----------|----------|---------------------|-------------------|-----------------|
| <b>3-TIER</b> |       |        |          |          |                     |                   |                 |
| 15            | 18    | 78     | 1-wide   | 3        | UELBP1588-3PL       | UELBP1588-3A-PL   | PL              |
| 45            | 18    | 78     | 3-wide   | 9        | UELBP3588-3PL       | UELBP3588-3A-PL   | PL              |
| 15            | 21    | 78     | 1-wide   | 3        | UELBP1518-3PL       | UELBP1518-3A-PL   | PL              |
| 45            | 21    | 78     | 3-wide   | 9        | UELBP3518-3PL       | UELBP3518-3A-PL   | PL              |
| 18            | 18    | 78     | 1-wide   | 3        | UELBP1888-3PL       | UELBP1888-3A-PL   | PL              |
| 54            | 18    | 78     | 3-wide   | 9        | UELBP3888-3PL       | UELBP3888-3A-PL   | PL              |
| 18            | 21    | 78     | 1-wide   | 3        | UELBP1818-3PL       | UELBP1818-3A-PL   | PL              |
| 54            | 21    | 78     | 3-wide   | 9        | UELBP3818-3PL       | UELBP3818-3A-PL   | PL              |
| <b>4-TIER</b> |       |        |          |          |                     |                   |                 |
| 15            | 18    | 78     | 1-wide   | 4        | UELBP1588-4PL       | UELBP1588-4A-PL   | PL              |
| 45            | 18    | 78     | 3-wide   | 12       | UELBP3588-4PL       | UELBP3588-4A-PL   | PL              |
| 15            | 21    | 78     | 1-wide   | 4        | UELBP1518-4PL       | UELBP1518-4A-PL   | PL              |
| 45            | 21    | 78     | 3-wide   | 12       | UELBP3518-4PL       | UELBP3518-4A-PL   | PL              |
| 18            | 18    | 78     | 1-wide   | 4        | UELBP1888-4PL       | UELBP1888-4A-PL   | PL              |
| 54            | 18    | 78     | 3-wide   | 12       | UELBP3888-4PL       | UELBP3888-4A-PL   | PL              |
| 18            | 21    | 78     | 1-wide   | 4        | UELBP1818-4PL       | UELBP1818-4A-PL   | PL              |
| 54            | 21    | 78     | 3-wide   | 12       | UELBP3818-4PL       | UELBP3818-4A-PL   | PL              |



711  
LIGHT GRAY (PL)

### GENERAL SPECIFICATIONS

**BODY CONSTRUCTION:** Knock down (KD) with 16 gauge solid top, bottom and intermediate shelves, 16 gauge perforated sides, 18 gauge solid back

**DOORS:** 14 gauge solid sheet steel

**FRAME:** 16 gauge welded frame

**DOOR STRIKE:** Continuous vertical door strike at both hinge and latch side

**HANDLE:** DigiTech™ electronic, code access lock serves as handle

**LATCHING:** Single-point cam latch

**HINGES:** 16 gauge continuous piano hinge

**SHELVES:** 1 fixed hat shelf per opening

**HOOKS:** none



**QUICKSHIP**

**CELL PHONE/TABLET LOCKERS**



BACKPACK / LAPTOP & CELL PHONE LOCKERS



**Prepared for Padlock**



**Keyed Cam Lock**



**Digitech H1™ Electronic Locks**



**2 YEAR WARRANTY**

**MOBILE DEVICE LOCKERS**

| OVERALL WIDTH | HEIGHT | DEPTH | GROUPING | OPENINGS PER GROUP | PADLOCK READY (PADLOCKS SOLD SEPARATELY) CAT NO. | WITH DIGITECH™ ELECTRONIC ACCESS LOCKS CAT NO. | WITH KEY CAM LOCK CAT NO. |
|---------------|--------|-------|----------|--------------------|--|--|---------------------------|
| 9             | 30 1/2 | 12    | 1-wide   | 5                  | UCTL192(30)-5A                                   | UCTL192(30)-5A-E                               | UCTL192(30)-5A-K          |
| 27            | 30 1/2 | 12    | 3-wide   | 15                 | UCTL392(30)-5A                                   | UCTL392(30)-5A-E                               | UCTL392(30)-5A-K          |

| CLEAR OPENING WIDTH | CLEAR OPENING HEIGHT | CLEAR OPENING DEPTH |
|---------------------|----------------------|---------------------|
| 7 1/2               | 5 1/2                | 11                  |



711 LIGHT GRAY (PL)



**GENERAL SPECIFICATIONS**

**BODY CONSTRUCTION:** 20 gauge cold rolled steel

**HINGES:** 16 gauge continuous piano hinge

**DOORS:** 20 gauge solid (non-vented)

**COAT RODS:** None

**HANDLE/LOCKS** Locks serve as door handle/pull

**SHELVES:** None

• **PADLOCK** Padlock hasp cam lock for padlocks by others

**HOOKS:** None

• **KEY LOCK** Cylinder cam locks

• **DIGITECH™ ELECTRONIC LOCK:** Pin code access electronic lock

**LEGS:** None

ships in temporary-use mode that can be programmed for permanent use

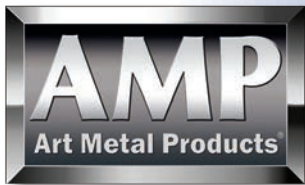

**QUICKSHIP**

# AMP BULK STORAGE LOCKERS



*AMP Bulk Storage Lockers are the most economical way to provide safe and secure storage in virtually any facility.*

*Choose from in-stock or custom sizes to fit your needs.*



- ✓ **Single & Double Tier**
- ✓ **Economical**
- ✓ **Secure**
- ✓ **Durable**
- ✓ **Fast & Easy Installation**
- ✓ **Low Life-Cycle Cost**
- ✓ **Attractive**
- ✓ **User Friendly**

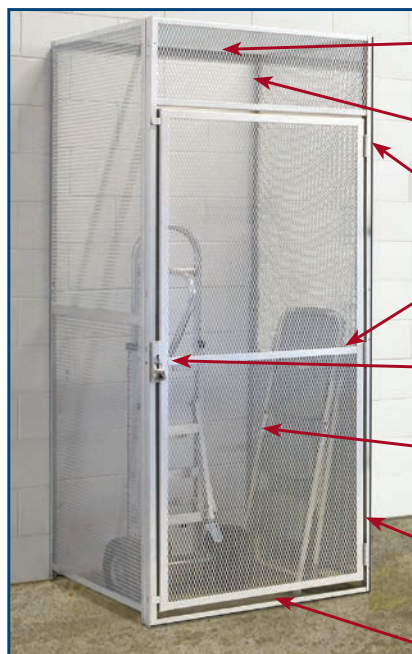

- Shown with optional expanded metal top
- 13" transom
- Heavy-duty 13 gauge 7-knuckle 3-1/2" butt hinges
- Welded door brace for added rigidity
- Welded padlock hasp and ergonomic welded-on door pull
- 1/2" 16 gauge flattened expanded metal doors and sides
- Heavy-gauge vertical frame channels and
- Horizontal frame angles

Single Tier Starter Unit



Optional 16 gauge 1/2" expanded metal top makes for a very secure structure adding rigidity and ensuring a higher level of protection from theft



The Heavy-Duty 7 knuckle hinges and door stops are welded to the frame for extra strength and security of contents, imparting a more finished and attractive appearance to the unit. Door handles are formed from one solid piece of steel and are welded to the frame for extra strength



711 LIGHT GRAY (PL)

**NOTE:** *In the interest of safety, all lockers must be securely anchored to the floor and/or wall.*

**QUICKSHIP**

# AMP BULK STORAGE LOCKERS



BULK STORAGE LOCKERS

## Custom Installations

AMP Bulk Storage Lockers' unique construction provides for a simple, easy way of handling interference from overhead pipes and/or ducts.

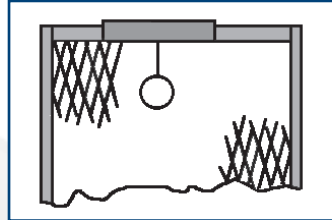
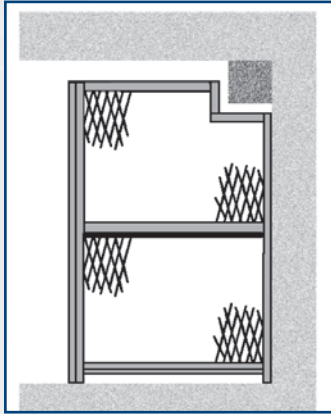

View of pipe through transom (or divider) with repair angle.

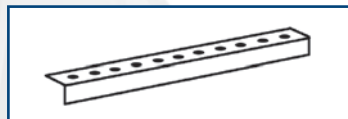

Showing cut out (with repair angles) to allow for interfering duct.

Repair Angles

**REPAIR ANGLE** 16 gauge 36" long repair angle is pre-punched on 2" centers to "heal" cuts in dividers or transom. Two bolts and clips are included with each angle.

Blue part number denotes in stock sizes. Custom sizes are also available.

### BULK STORAGE LOCKER STOCK SIZES

Width 36" 48" 60"  
Depths 36" 48" 60"  
Height 90"

Standard Sizes available in single and double tier configurations.

\*Custom sizes are also available.

### OPTIONS

**TOPS** are recommended for situations where the ceiling height is 8'-6" or more when using standard 7'-6" high component modules.

**SHELVES** are used as dividers between top and bottom openings of double tier lockers. May also be used in single tier lockers for additional floor space and may be shorter than depth of locker to provide space for long items.

**BACKS** are required for back-to-back installations or where a single row is set away from a wall.

**BOTTOMS** are recommended for use on all single or double tier lockers if dampness prevails.

| STARTER UNITS                       |    |    | ADDER UNITS                |                           |                            |                           |
|-------------------------------------|----|----|----------------------------|---------------------------|----------------------------|---------------------------|
| W                                   | D  | H  | Part No.<br>(Right Hinged) | Part No.<br>(Left Hinged) | Part No.<br>(Right Hinged) | Part No.<br>(Left Hinged) |
| <b>SINGLE TIER</b>                  |    |    |                            |                           |                            |                           |
| 36                                  | 36 | 90 | BSL363690-R-1S-PL          | BSL363690-L-1S-PL         | BSL363690-R-1A-PL          | BSL363690-L-1A-PL         |
| 36                                  | 48 | 90 | BSL364890-R-1S-PL          | BSL364890-L-1S-PL         | BSL364890-R-1A-PL          | BSL364890-L-1A-PL         |
| 36                                  | 60 | 90 | BSL366090-R-1S-PL          | BSL366090-L-1S-PL         | BSL366090-R-1A-PL          | BSL366090-L-1A-PL         |
| 48                                  | 36 | 90 | BSL483690-R-1S-PL          | BSL483690-L-1S-PL         | BSL483690-R-1A-PL          | BSL483690-L-1A-PL         |
| 48                                  | 48 | 90 | BSL484890-R-1S-PL          | BSL484890-L-1S-PL         | BSL484890-R-1A-PL          | BSL484890-L-1A-PL         |
| 48                                  | 60 | 90 | BSL486090-R-1S-PL          | BSL486090-L-1S-PL         | BSL486090-R-1A-PL          | BSL486090-L-1A-PL         |
| <b>DOUBLE TIER</b>                  |    |    |                            |                           |                            |                           |
| 36                                  | 36 | 45 | BSL363690-R-2S-PL          | BSL363690-L-2S-PL         | BSL363690-R-2A-PL          | BSL363690-L-2A-PL         |
| 36                                  | 48 | 45 | BSL364890-R-2S-PL          | BSL364890-L-2S-PL         | BSL364890-R-2A-PL          | BSL364890-L-2A-PL         |
| 36                                  | 60 | 45 | BSL366090-R-2S-PL          | BSL366090-L-2S-PL         | BSL366090-R-2A-PL          | BSL366090-L-2A-PL         |
| 48                                  | 36 | 45 | BSL483690-R-2S-PL          | BSL483690-L-2S-PL         | BSL483690-R-2A-PL          | BSL483690-L-2A-PL         |
| 48                                  | 48 | 45 | BSL484890-R-2S-PL          | BSL484890-L-2S-PL         | BSL484890-R-2A-PL          | BSL484890-L-2A-PL         |
| 48                                  | 60 | 45 | BSL486090-R-2S-PL          | BSL486090-L-2S-PL         | BSL486090-R-2A-PL          | BSL486090-L-2A-PL         |
| <b>ACCESSORIES FOR BULK STORAGE</b> |    |    |                            |                           |                            |                           |
| <b>TOP PANELS</b>                   |    |    |                            |                           |                            |                           |
| 36                                  | 36 |    | 4803636PL                  |                           |                            |                           |
| 36                                  | 48 |    | 4803648PL                  |                           |                            |                           |
| 36                                  | 60 |    | 4803660PL                  |                           |                            |                           |
| 48                                  | 36 |    | 4804836PL                  |                           |                            |                           |
| 48                                  | 48 |    | 4804848PL                  |                           |                            |                           |
| 48                                  | 60 |    | 4804860PL                  |                           |                            |                           |
| <b>FRONT EXTENSION PANELS</b>       |    |    |                            |                           |                            |                           |
| 6                                   |    | 90 | 4600690PL                  |                           |                            |                           |
| 12                                  |    | 90 | 4601290PL                  |                           |                            |                           |
| 18                                  |    | 90 | 4601890PL                  |                           |                            |                           |
| 24                                  |    | 90 | 4602490PL                  |                           |                            |                           |
| <b>BACK PANELS</b>                  |    |    |                            |                           |                            |                           |
| 36                                  |    | 90 | 4703690PL                  |                           |                            |                           |
| 48                                  |    | 90 | 4704890PL                  |                           |                            |                           |
| <b>REPAIR ANGLES</b>                |    |    |                            |                           |                            |                           |
| 36                                  |    |    | 20100                      |                           |                            |                           |

• **Single Tier:**  
Overall Height 90"  
Opening Height: 75-1/2"

• **Double Tier:**  
Overall Height 90"  
Upper Opening Height: 31-1/2"  
Lower Opening Height: 42"

• **Doors:** available right-hand or left-hand hinged



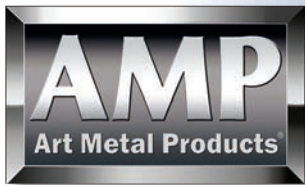

# 24/7 PARCEL LOCKER

The locker features the NEW Hollowell DIGITECH™ H1 digital lock, a slimline ultra modern look and simple to operate.

## Easily Manage Tenant Package Delivery

### CONCIERGE...

1. Receives package for tenant
2. Places package in locker
3. Locks door using 4-digit PIN
4. Texts or emails Locker Number and PIN to Tenant

### TENANT, AT HIS/HER CONVENIENCE...

1. Enters PIN into lock of appropriate locker
2. Removes package
3. Closes door of now empty locker, PIN is erased

### LOCKER FEATURES

- All-Welded Unibody Construction
- 14 Gauge solid steel doors with 16 Gauge piano hinge
- 16 Gauge solid steel body & 18 Gauge steel backs
- DigiTech H1 electronic locks
- Ships fully-assembled



711  
LIGHT GRAY (PL)

### POPULAR LOCKER CONFIGURATIONS



**HEPL642-11**  
2-DOOR PARCEL LOCKER  
36" x 24" x 72" Locker  
(2) 18" x 72" doors



**HEPL842-22**  
4-DOOR PARCEL LOCKER  
36" x 24" x 72" Locker  
(4) 18" x 36" doors



**HEPL842-33**  
6-DOOR PARCEL LOCKER  
36" x 24" x 72" Locker  
(6) 18" x 24" doors



**HEPL842-55**  
10-DOOR PARCEL LOCKER  
36" x 24" x 72" Locker  
(6) 18" x 8" doors above  
(4) 18" x 24" doors at bottom



**HEPL842-77**  
14-DOOR PARCEL LOCKER  
36" x 24" x 72" Locker  
(12) 18" x 8" doors above  
(2) 18" x 24" doors at bottom



**HEPL842-99**  
18-DOOR PARCEL LOCKER  
36" x 24" x 72" Locker  
(18) 18" x 8" doors

### GENERAL SPECIFICATIONS

**BODY:** All-Welded Unibody Construction 16 gauge solid body with 18 ga backs

**DOORS:** 14 ga solid doors with 16 ga piano hinge

**LOCKS:** DigiTech horizontal electronic locks Ships fully-assembled, locks installed in field

**COLOR:** Light Gray (PL)

## 24/7 PARCEL LOCKER LETS YOU RECEIVE AND PICK UP ANYTIME.



NEW

### DIGITECH H1 ELECTRONIC LOCKS

#### SECURITY CODE LOCK FEATURES

- 8-digit master and sub-master codes for two levels of management security.

#### CR123 LITHIUM BATTERY (INCLUDED)

- Provides over 10,000 normal uses.
- LED's Flash to indicate low battery level

#### MASTER KEY

- Locker can be opened with master key if batteries are exhausted.

#### PERMANENT MODE TOO

- User enters a pre-programmed 4-digit code to unlock and use locker repeatedly.



Green indicator ring

- Secure pop-out turn handle (flush when locked)





# AMP PORTABLE GATES



## AMP PORTABLE GATES

### ARE IDEAL FOR:

- SCHOOLS
- SHOPPING MALLS
- RECREATION CENTERS
- FACTORIES
- LIBRARIES
- HOSPITALS
- OFFICE BUILDINGS
- FINANCIAL INSTITUTIONS
- THEATERS
- MUSEUMS



### SECURITY • TRAFFIC CONTROL • PORTABILITY

- In Stock for shipment within 5 days of receipt of order
- Quick and easy installation. Install between two walls instantly without anchors to walls or floor
- Simplified, patented pressure lock system
- Floor anchors are not required but are valuable for special installations
- Compact, fold-up size and heavy duty swivel casters make moving and storage easy
- Plated finish
- Padlock hasp is standard
- Cylinder locks are available for additional security
- Two or more gates can be joined together for large expanse

### EXCLUSIVE AMP PRESSURE LOCK SYSTEM WORKS LIKE THIS:

1. Raise unit retainer channel to vertical position and secure
2. Extend gate until rubber bumpers touch both walls
3. Lower the male lock channel (with pin) until it rests on carriage channels within guides and locking bracket
4. Lower female lock channel (with adjustment holes) until it rests within the male lock channel with pin. Pin need not engage a hole in female lock channel
5. Raise both channels until pin engages the hole immediately to the right. Applying moderate pressure, push both channels down until they rest within guides and locking bracket. Lock in position

Five sizes to accommodate 3'-6" wide to 18'-0" wide conditions. Connect multiple gates together for wider applications.

| AMP PORTABLE GATES |                    |                |           |              |
|--------------------|--------------------|----------------|-----------|--------------|
| Model              | For Openings       | Collapsed Size | Height    | Weight (lbs) |
| P601-06            | 3'-6" to 6'-0"     | 19" x 30"      | 6'-6-1/2" | 193          |
| P601-09            | 6'-0" to 9'-0"     | 19" x 30"      | 6'-6-1/2" | 197          |
| P601-12            | 7'-0" to 12'-0"    | 24" x 30"      | 6'-6-1/2" | 254          |
| P601-15            | 11'-0" to 15'-0"   | 30" x 30"      | 6'-6-1/2" | 311          |
| P601-18            | 13'-0" to 18'-0"   | 30" x 30"      | 6'-6-1/2" | 374          |
| PG-CL              | Cylinder Locks     |                |           |              |
| PG-FAA             | Floor Anchors      |                |           |              |
| PG-A               | Additional Anchors |                |           |              |



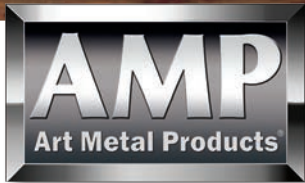

- Custom Wood Lockers
- Sport Lockers
- Country Club Lockers
- Fitness Center Lockers
- Health Spa Lockers



## IDEAL CHOICE FOR YOUR NEXT WOOD LOCKER PROJECT

### *Bring Prestige to your Organization with Custom Wood Lockers*

Create a memorable environment for your current members, impress your potential members or dazzle day-use customers with AMP Custom Recruiter Wood Lockers. Our lockers bring an upscale and luxurious design to your locker room with a very reasonable lifecycle cost. We use the finest materials, and

finish our lockers with a two coat, catalyzed, clear cabinet lacquer to keep the finish looking like new year-in and year-out. Each locker is hand crafted by expert craftsmen using state-of-the-art equipment to create an heirloom quality masterpiece.





## REINFORCE YOUR COMMITMENT TO YOUR PLAYERS!

# RECRUITER

WOOD SPORT LOCKERS

Equip them with the industry's finest all-wood sport lockers. AMP Recruiter™ custom wood sport lockers are made to order,

and offer a variety of different options allowing you to tailor your locker room to your team's specific requirements.



Optional LED Lighting under locker top and/or under shelf



Optional USB & 110 power outlet inside upper security box



Optional dual fan ventilation system for forced air ventilation of foot locker





# CUSTOM WOOD SPORT LOCKERS

In addition to our standard stock designs and sizes, our engineers are readily available to assist you in custom designing a locker to meet your specific needs. Be it a fitness center, team locker

room, country club or resort health spa, we stand behind our product with a full one year warranty that covers defects in materials and workmanship.

## FIVE SIDE OPTIONS



Set Back Sides



Full Curve Sides



Standard Sides



Slant Sides



Half Curve Sides

## OPTIONAL FEATURES



Name plate holders



Shoulder pad rack



Shoulder pad & helmet rack



Foot locker front panel mesh insert



Engraved team logo on security box door.



Padded Seat Cushion

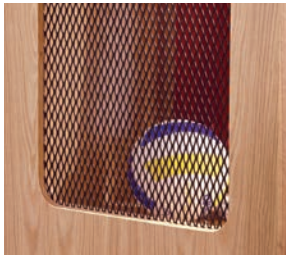

Optional mesh expanded metal side inserts for additional ventilation



Optional Bat / Lacrosse Stick Caddy

LOCK OPTIONS: • Padlock • Built in combination lock • Mechanical lock • Electronic locks



## Introducing our New Recruiter™ Set-Back QUICK-SHIP Design

*The beauty is in the details...  
These lockers are high quality fine furniture. We take special pride in  
ensuring that each locker is a true work of art. All are made in our own  
manufacturing plant and shipped directly to you.*

### QUICK-SHIP LOCK OPTIONS

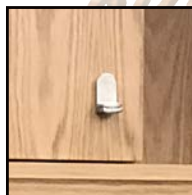

STANDARD  
PADLOCK CAM  
HASP

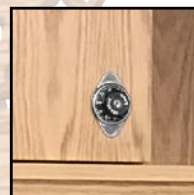

BUILT IN  
COMBINATION LOCK



DIGITECH-H1™  
ELECTRONIC LOCK



24" & 30" Wide Models Available From Quick-Ship

Stock Locker:  
24"/30"W x 24"D x 84"H  
Starter Unit Shown  
Includes Two Finished End Panels



RED OAK



MADE IN  
THE USA



# A POWERFUL RECRUITING TOOL

## OPTIONAL ADD ON ACCESSORIES



Seat Cushion (Black)  
SC2424BK  
SC3024BK



Name Plate Holder  
NPH-0212S (12" wide)  
NPH-0218S (18" wide)



Shoulder Pad Rack  
SPHR14R



Shoulder Pad & Helmet Rack  
SPHR18R



USB Outlet in Security Box  
USB-4  
USB-4-110

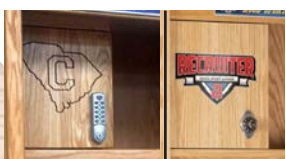

Engraved Logo or UV Full Color Print  
on security box door RLDOOR-  
LOGO

### OPTIONAL WOOD CHOICE

(Additional Lead-time Apply)

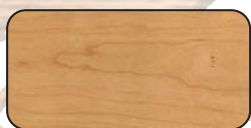

CHERRY

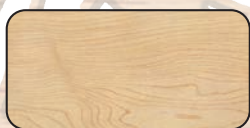

MAPLE

### ADDITIONAL QUICK-SHIP ACCESSORIES

(Additional Lead-time Apply)

- Logo UV Full Color Print Box Door, RLDOORLOGO
- End Filler 15", RLEF1584
- Corner Filler 15" x 15", RLCF151584

### SIDE PROFILE OPTIONS

(Additional Lead-time Apply)



STRAIGHT SLANT HALF CURVE FULL CURVE



| WIDTH                         | DEPTH | HEIGHT | CATALOG NUMBER |
|-------------------------------|-------|--------|----------------|
| <b>RECRUITER WOOD LOCKERS</b> |       |        |                |
| 24                            | 24    | 84     | RL242484-1SB   |
| 30                            | 24    | 84     | RL302484-1SB   |
| <b>FINISHED END PANELS</b>    |       |        |                |
| -                             | 24    | 84     | RLEP2484L      |
| -                             | 24    | 84     | RLEP2484R      |

Starter units include (2) finished end panels to be used at row ends  
Adder units do not include finished end panels  
Order (1) Starter unit for each straight run of lockers and Adder units to fill out the run

### LOCKER FEATURES

- FURNITURE GRADE RED OAK HARDWOOD  
Two Coats of Formaldehyde-Free Catalyzed Conversion Varnish for Excellent Moisture Resistance
- MODERN CONTOUR EDGES WITH WOOD EDGE BANDING
- UPPER SECURITY BOX
- THREE LOCK OPTIONS
- LOWER FOOT LOCKER/SEAT
- STAINLESS STEEL COAT ROD
- THREE STAINLESS STEEL HOOKS
- STARTER/ADDER UNIT CONFIGURATIONS  
• 24" X 24" X 84" AND 30" X 24" X 84"
- SHIPS FULLY-ASSEMBLED
- INCLUDES TOE KICK MATERIAL
- 2 X 4 SUB-BASE BY OTHERS



**15 YEAR WARRANTY**

# SOLID PLASTIC LOCKERS

## **AQUAMAX** HDPE PLASTIC LOCKERS

Aquamax Solid Plastic Lockers are Ideal for applications where high humidity, moisture and water are present. Plastic lockers are fabricated from solid high density polyethylene panels (HDPE) for maximum strength and durability while providing corrosion resistance to most common chemicals.



Available in single, double, triple, four, five, six and "Z" tier configurations

- Mildew and Odor Resistant**
- Graffiti Resistant**
- Chemical Resistant**

*Z-Tier: Multi-height storage with extended hanging space*



**WARDROBE DOORS:**  
Projecting solid plastic handle with lift-type latching

### STANDARD

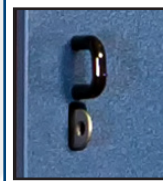

**BOX LOCKER DOORS:**  
Single-point thru-the-door projecting friction catch door pull with padlock hasp

| AQUAMAX SIZES |       |       |           |
|---------------|-------|-------|-----------|
| MODEL         | WIDTH | DEPTH | HEIGHT    |
| 1-Tier        | 12"   | 18"   | 72"       |
| 2-Tier        | 12"   | 18"   | 36" / 72" |
| 3-Tier        | 12"   | 18"   | 24" / 72" |
| 6-Tier        | 12"   | 18"   | 12" / 72" |
| Z-Tier        | 12"   | 18"   | 42" / 72" |

### FEATURES

**BODY CONSTRUCTION:** Knock-down, 24 gauge, High density (HDPE) Polyethylene plastic, 3/8" thick body panels

**DOORS:** 1/2" thick solid HDPE plain doors with perimeter ventilation

**HANDLE :** Wardrobe doors have a projecting solid plastic lift handle. Box doors 18" and under include a single-point projecting padlock hasp with door pull

**LATCHING:** Full-height lift-type latching for single, double and triple tier wardrobe lockers

**HINGES:** Continuous aluminum hinge is powder coated

**HOOKS:** Two stainless steel single prong hooks in single and double tier

**SHELVES :** Upper hat shelf and lower shelf included in single tier lockers 60" and 72" high

**NOTES :** All doors prepared for use with padlock locks not included). Production locker body components are available in white only. See color selections on page 85





# ANTIMICROBIAL HDPE PLASTIC LOCKERS

Solid Plastic (HDPE) Production Lockers are perfect for use in wet environments, such as showers areas, and pools.



**HDPE CONTAINS A SPECIALLY FORMULATED ANTIMICROBIAL AGENT THAT PERMANENTLY RESISTS THE GROWTH OF BACTERIA, YEAST AND MILDEW.**

**ANTIMICROBIAL PROTECTION FOR OVER 20 YEARS!**

MedSafe AquaMax lockers are manufactured with high density polyethylene (HDPE), containing a specially formulated ANTIMICROBIAL agent that permanently resists the growth of bacteria, mold, yeast and mildew. This special feature, combined with all the great features of our AquaMax lockers, make these lockers ideal for use in medical, educational, retail and manufacturing environments.



1-Tier,  
1 wide

2-Tier,  
1 wide

Z-Tier,  
1 wide

## STANDARD SIZES

|               |             |
|---------------|-------------|
| <b>WIDTH</b>  | 12" 15" 18" |
| <b>DEPTH</b>  | 12" 15" 18" |
| <b>HEIGHT</b> | 60" 72"     |

Available in single, double, and "Z" tier configurations

## FEATURES

**BODY CONSTRUCTION:** Knock-down, 24 gauge, High density (HDPE) Polyethylene plastic, 3/8" thick body panels

**DOORS:** 1/2" thick solid HDPE plain doors with perimeter ventilation

**HANDLE:** Wardrobe doors have a projecting solid plastic lift handle. Box doors 18" and under include a single-point projecting padlock hasp with door pull

**LATCHING:** Full-height lift-type latching for single, double and triple tier wardrobe lockers

**HINGES:** Continuous aluminum hinge is powder coated  
Hooks: Two stainless steel single prong hooks in single and double tier

**SHELVES:** Upper hat shelf and lower shelf included in single tier lockers 60" and 72" high

**NOTES:** All doors prepared for use with padlock locks not included). Production locker body components are available in white only.



## SOLID PHENOLIC LOCKERS

### **VERSAMAX** SOLID PHENOLIC LOCKERS

VersaMax™ Solid Phenolic lockers are engineered to the same high level of integrity found throughout our AMP locker line.

*The unique qualities of phenolic resin offer many value added benefits:*

- ✓ **Environmentally Smart**
- ✓ **Moisture Resistant, perfect for wet or damp areas**
- ✓ **Mold and mildew resistant**
- ✓ **Many colors and finish options**
- ✓ **Laminate surface is graffiti and scratch resistant**



### **RECRUITER** Phenolic Sport Lockers



Phenolic Sport lockers are available in various standard styles designed to meet the needs of today's versatile athletes. Sport lockers can also be customized to meet your team's specific needs.





# SOLID PHENOLIC LOCKERS

Fully assembled single unit construction. End panels and filler panels are recommended for a finished installation. Designed with mortise & tenon joints, stainless steel fasteners and frame-less doors

**18 STANDARD COLORS**

See page 89 for color choices

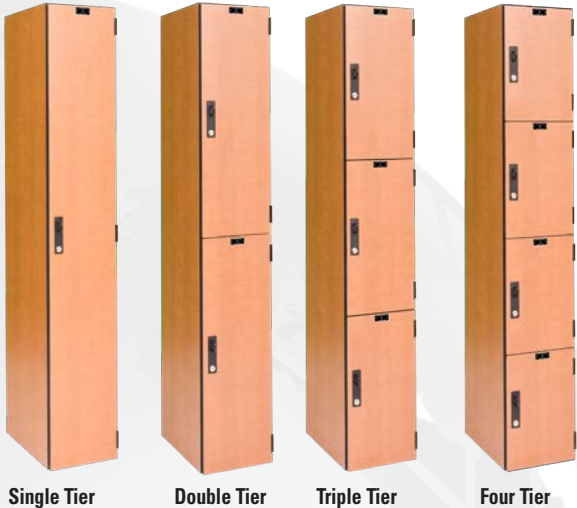

Single Tier Double Tier Triple Tier Four Tier

- **Single Tier** lockers are perfect for hanging of longer garments
- **Double Tier** lockers offer plenty of height for hanging coats and garments while using half the floor space of a single tier locker
- **Triple Tier** lockers are our most economical wardrobe locker allowing hanging garments to be draped from the coat hook
- **Four Tier** lockers provide ample storage for larger personal items like backpacks, totes, etc

**Various locking options:**

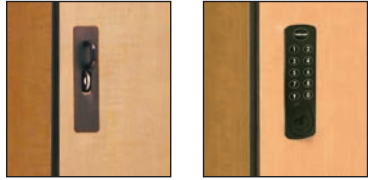

Padlock Hasp Electronic Locks

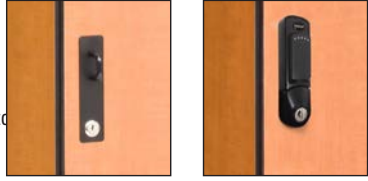

Built-In Key Locks RFID Locks



Built-In Combination Locks Mechanical Shared Use Locks



Coin or Token Locks



ADA Compliant Locks Available

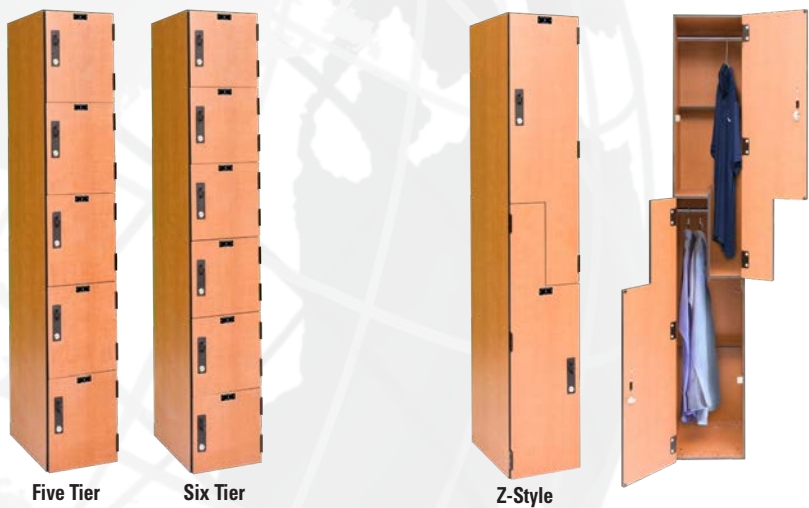

Five Tier Six Tier Z-Style

- **Five Tier** lockers are available in 12" and 14.4" high openings allowing for storage of personal belongings
- **Six Tier** lockers are our most economical storage solution offers storage of purses, bags, phones and other smaller personal items

- **Z-Style** Lockers are the perfect compromise between single and double tier lockers offering the perfect solution when space is at a premium, but hanging of longer garments is needed.

| STOCK PHENOLIC LOCKER SIZES |       |       |                |                |
|-----------------------------|-------|-------|----------------|----------------|
| Tier                        | Width | Depth | Opening Height | Overall Height |
| Single Tier                 | 12    | 18    | 72             | 72             |
| Double Tier                 | 12    | 18    | 36             | 72             |
| Six Tier                    | 12    | 18    | 12             | 72             |
| Z-Tier                      | 12    | 18    | 42             | 72             |

## GENERAL SPECIFICATIONS

**BODY CONSTRUCTION:** Phenolic construction, Sides and backs are 5/16" thick. Tops, bottoms and shelves are 3/8" thick.

**DOORS:** 1/2" thick solid phenolic with perimeter ventilation.

**SHELVES :** Hat shelf for single tier 60" & 72" lockers

## PRODUCTION PHENOLIC LOCKER SIZES

| Tier        | Width                  | Depth                   | Opening Height     | Overall Height     |
|-------------|------------------------|-------------------------|--------------------|--------------------|
| Single Tier | 9", 12", 15", 18", 24" | 12", 15", 18", 20", 24" | 36", 48", 60", 72" | 36", 48", 60", 72" |
| Double Tier | 9", 12", 15", 18", 24" | 12", 15", 18", 20"      | 18", 24", 30", 36" | 36", 48", 60", 72" |
| Triple Tier | 9", 12", 15", 18"      | 12", 15", 18", 20"      | 12", 20", 24"      | 36", 60", 72"      |
| Four Tier   | 9", 12", 15", 18"      | 12", 15", 18", 20"      | 12", 15", 18"      | 48", 60", 72"      |
| Five Tier   | 9", 12", 15", 18"      | 12", 15", 18", 20"      | 12", 14.4"         | 60", 72"           |
| Six Tier    | 9", 12", 15", 18"      | 12", 15", 18", 20"      | 12"                | 72"                |
| Z-Style     | 12", 15", 18"          | 12", 15", 18", 20"      | 36/24", 42", /30"  | 60", 72"           |
| Sport       | 18", 24"               | 18", 20", 24"           | N/A                | 72", 84"           |

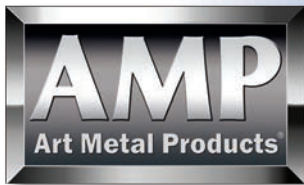

**QUICKSHIP**

**OPEN SHELVING-MEDIUM,  
HEAVY AND EXTRA HEAVY-DUTY**



**Open Starter Units Include:**

Two beaded front posts, two angle back posts, one pair of back sway braces, two pair of side sway braces and shelves with shelf clips applicable to unit ordered.



**Open Adder Units Include:**

One beaded front post, two angle back posts, one pair of back sway braces, one pair of side sway braces and shelves with shelf clips applicable to unit ordered.



Box beam adjustable shelves



**COLOR SELECTION**

725  
HALLOWELL GRAY  
(HG)



**HEAVY DUTY SHELVES**

- Tubular flange front and rear for greater strength
- Exclusive triple bend side flanges for added strength
- Lapped and welded corners
- Top of shelf is punched to accept shelf dividers
- Uses four one piece shelf clips per shelf
- Can be installed together with both Beaded Front and Angle Back Posts as well as T-Posts and H-Posts



**ANGLE BACK POSTS & T-POSTS**

- Roll formed into a unique angle shape for maximum strength
- The long leg is punched on 1-1/2" centers to allow independent shelf adjustment
- Angle Posts can be used in place of Beaded Front Posts if desired

# QUICKSHIP

## CLOSED SHELVING-MEDIUM, HEAVY AND EXTRA HEAVY-DUTY



### Closed Starter Units Include:

Two beaded front posts, two angle back posts, one set of back panels, two sets of side panels and shelves with shelf clips applicable to unit ordered.



### Closed Adder Units Include:

One beaded front post, two angle back posts, one set of back panels, one set of side panels and shelves with shelf clips applicable to unit ordered.

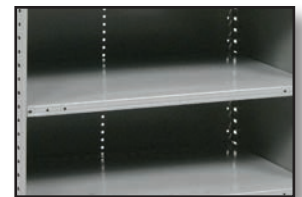

Box beam adjustable shelves



Base strip closes bottom to prevent debris accumulation



Optional swinging doors allow cabinet-style storage



Shelf dividers for organized storage



### BEADED FRONT POSTS

- Beaded for strength
- Flush to permit straight-in/straight-out shelf installation, shelf changing and shelf loading. No tilting needed
- Get the full use of shelf area
- Punched on 1-1/2" centers to allow positioning of one shelf independent of other shelves



### H-POSTS

- Designed for high-density applications
- More than twice the capacity of standard posts
- Used at front and back
- Used with standard Hi-Tech components



### ONE PIECE SHELF CLIP

- Each shelf requires four of these sturdy and compact clips
- Clips key firmly into post slots to hold shelves securely in place
- Fits Beaded Front, Angle Back Posts, T-Posts and H-Posts
- Provides independent shelf positioning on 1-1/2" centers
- Non-Intrusive clip sits flush with inside edge of front posts



**QUICKSHIP**

**OPEN SHELVING-MEDIUM,  
HEAVY AND EXTRA HEAVY-DUTY**



**OPEN  
TYPE  
STARTER**



**OPEN  
TYPE  
ADDER**



**5 SHELVES**



**6 SHELVES**



**8 SHELVES**

| W                            | D  | H  |         | 5-Shelf Unit<br>SKU No. | 6-Shelf Unit<br>SKU No. | 8-Shelf Unit<br>SKU No. | Shelf<br>Capacity* |
|------------------------------|----|----|---------|-------------------------|-------------------------|-------------------------|--------------------|
| <b>Medium-Duty</b>           |    |    |         |                         |                         |                         |                    |
| 36                           | 12 | 87 | Starter | 4510-12                 | 4511-12                 | 4513-12                 | 500*               |
| 36                           | 12 | 87 | Adder   | A4510-12                | A4511-12                | A4513-12                | 500*               |
| 36                           | 18 | 87 | Starter | 4510-18                 | 4511-18                 | 4513-18                 | 500*               |
| 36                           | 18 | 87 | Adder   | A4510-18                | A4511-18                | A4513-18                | 500*               |
| 36                           | 24 | 87 | Starter | 4510-24                 | 4511-24                 | 4513-24                 | 500*               |
| 36                           | 24 | 87 | Adder   | A4510-24                | A4511-24                | A4513-24                | 500*               |
| 48                           | 12 | 87 | Starter | 4710-12                 | 4711-12                 | 4713-12                 | 375*               |
| 48                           | 12 | 87 | Adder   | A4710-12                | A4711-12                | A4713-12                | 375*               |
| 48                           | 18 | 87 | Starter | 4710-18                 | 4711-18                 | 4713-18                 | 375*               |
| 48                           | 18 | 87 | Adder   | A4710-18                | A4711-18                | A4713-18                | 375*               |
| 48                           | 24 | 87 | Starter | 4710-24                 | 4711-24                 | 4713-24                 | 350*               |
| 48                           | 24 | 87 | Adder   | A4710-24                | A4711-24                | A4713-24                | 350*               |
| <b>Heavy-Duty</b>            |    |    |         |                         |                         |                         |                    |
| 36                           | 12 | 87 | Starter | 5510-12                 | 5511-12                 | 5513-12                 | 800*               |
| 36                           | 12 | 87 | Adder   | A5510-12                | A5511-12                | A5513-12                | 800*               |
| 36                           | 18 | 87 | Starter | 5510-18                 | 5511-18                 | 5513-18                 | 800*               |
| 36                           | 18 | 87 | Adder   | A5510-18                | A5511-18                | A5513-18                | 800*               |
| 36                           | 24 | 87 | Starter | 5510-24                 | 5511-24                 | 5513-24                 | 800*               |
| 36                           | 24 | 87 | Adder   | A5510-24                | A5511-24                | A5513-24                | 800*               |
| 48                           | 12 | 87 | Starter | 5710-12                 | 5711-12                 | 5713-12                 | 400*               |
| 48                           | 12 | 87 | Adder   | A5710-12                | A5711-12                | A5713-12                | 400*               |
| 48                           | 18 | 87 | Starter | 5710-18                 | 5711-18                 | 5713-18                 | 450*               |
| 48                           | 18 | 87 | Adder   | A5710-18                | A5711-18                | A5713-18                | 450*               |
| 48                           | 24 | 87 | Starter | 5710-24                 | 5711-24                 | 5713-24                 | 500*               |
| 48                           | 24 | 87 | Adder   | A5710-24                | A5711-24                | A5713-24                | 500*               |
| <b>Extra Heavy-Duty Duty</b> |    |    |         |                         |                         |                         |                    |
| 36                           | 12 | 87 | Starter | 7510-12                 | 7511-12                 | 7513-12                 | 1100*              |
| 36                           | 12 | 87 | Adder   | A7510-12                | A7511-12                | A7513-12                | 1100*              |
| 36                           | 18 | 87 | Starter | 7510-18                 | 7511-18                 | 7513-18                 | 1200*              |
| 36                           | 18 | 87 | Adder   | A7510-18                | A7511-18                | A7513-18                | 1200*              |
| 36                           | 24 | 87 | Starter | 7510-24                 | 7511-24                 | 7513-24                 | 1250*              |
| 36                           | 24 | 87 | Adder   | A7510-24                | A7511-24                | A7513-24                | 1250*              |
| 48                           | 12 | 87 | Starter | 7710-12                 | 7711-12                 | 7713-12                 | 750*               |
| 48                           | 12 | 87 | Adder   | A7710-12                | A7711-12                | A7713-12                | 750*               |
| 48                           | 18 | 87 | Starter | 7710-18                 | 7711-18                 | 7713-18                 | 900*               |
| 48                           | 18 | 87 | Adder   | A7710-18                | A7711-18                | A7713-18                | 900*               |
| 48                           | 24 | 87 | Starter | 7710-24                 | 7711-24                 | 7713-24                 | 900*               |
| 48                           | 24 | 87 | Adder   | A7710-24                | A7711-24                | A7713-24                | 900*               |
| <b>Additional Shelves</b>    |    |    |         | <b>Medium-Duty</b>      | <b>Heavy-Duty</b>       | <b>Extra Heavy-Duty</b> |                    |
| 36                           | 12 |    |         | 5135-3612               | 5138-3612               | 5139-3612               | See Above          |
| 36                           | 18 |    |         | 5135-3618               | 5138-3618               | 5139-3618               | See Above          |
| 36                           | 24 |    |         | 5135-3624               | 5138-3624               | 5139-3624               | See Above          |
| 48                           | 12 |    |         | 5135-4812               | 5138-4812               | 5139-4812               | See Above          |
| 48                           | 18 |    |         | 5135-4818               | 5138-4818               | 5139-4818               | See Above          |
| 48                           | 24 |    |         | 5135-4824               | 5138-4824               | 5139-4824               | See Above          |

\*Shelf capacity based on factor of 1.65.

**NOTES:** Color for all components 725 Hallowell Gray

**OPEN UNITS:** Starter units include two beaded front posts, two angle back posts, one pair back sway braces, two pair side sway braces and 5-8 shelves. Adder units include one beaded front post, two angle back posts, one pair back sway braces, one pair side sway braces and 5-8 shelves.

# QUICKSHIP

## CLOSED SHELVING-MEDIUM, HEAVY AND EXTRA HEAVY-DUTY



| W                            | D  | H  |         | 5-Shelf Unit<br>SKU No. | 6-Shelf Unit<br>SKU No. | 8-Shelf Unit<br>SKU No. | Shelf<br>Capacity* |
|------------------------------|----|----|---------|-------------------------|-------------------------|-------------------------|--------------------|
| <b>Medium-Duty</b>           |    |    |         |                         |                         |                         |                    |
| 36                           | 12 | 87 | Starter | 4520-12                 | 4521-12                 | 4523-12                 | 500*               |
| 36                           | 12 | 87 | Adder   | A4520-12                | A4521-12                | A4523-12                | 500*               |
| 36                           | 18 | 87 | Starter | 4520-18                 | 4521-18                 | 4523-18                 | 500*               |
| 36                           | 18 | 87 | Adder   | A4520-18                | A4521-18                | A4523-18                | 500*               |
| 36                           | 24 | 87 | Starter | 4520-24                 | 4521-24                 | 4523-24                 | 500*               |
| 36                           | 24 | 87 | Adder   | A4520-24                | A4511-24                | A4523-24                | 500*               |
| 48                           | 12 | 87 | Starter | 4720-12                 | 4721-12                 | 4723-12                 | 375*               |
| 48                           | 12 | 87 | Adder   | A4720-12                | A4721-12                | A4723-12                | 375*               |
| 48                           | 18 | 87 | Starter | 4720-18                 | 4721-18                 | 4723-18                 | 375*               |
| 48                           | 18 | 87 | Adder   | A4720-18                | A4721-18                | A4723-18                | 375*               |
| 48                           | 24 | 87 | Starter | 4720-24                 | 4721-24                 | 4723-24                 | 350*               |
| 48                           | 24 | 87 | Adder   | A4720-24                | A4721-24                | A4723-24                | 350*               |
| <b>Heavy-Duty</b>            |    |    |         |                         |                         |                         |                    |
| 36                           | 12 | 87 | Starter | 5520-12                 | 5521-12                 | 5523-12                 | 800*               |
| 36                           | 12 | 87 | Adder   | A5520-12                | A5521-12                | A5523-12                | 800*               |
| 36                           | 18 | 87 | Starter | 5520-18                 | 5521-18                 | 5523-18                 | 800*               |
| 36                           | 18 | 87 | Adder   | A5520-18                | A5521-18                | A5523-18                | 800*               |
| 36                           | 24 | 87 | Starter | 5520-24                 | 5521-24                 | 5523-24                 | 800*               |
| 36                           | 24 | 87 | Adder   | A5520-24                | A5521-24                | A5523-24                | 800*               |
| 48                           | 12 | 87 | Starter | 5720-12                 | 5721-12                 | 5723-12                 | 400*               |
| 48                           | 12 | 87 | Adder   | A5720-12                | A5721-12                | A5723-12                | 400*               |
| 48                           | 18 | 87 | Starter | 5720-18                 | 5721-18                 | 5723-18                 | 450*               |
| 48                           | 18 | 87 | Adder   | A5720-18                | A5721-18                | A5723-18                | 450*               |
| 48                           | 24 | 87 | Starter | 5720-24                 | 5721-24                 | 5723-24                 | 500*               |
| 48                           | 24 | 87 | Adder   | A5720-24                | A5711-24                | A5723-24                | 500*               |
| <b>Extra Heavy-Duty Duty</b> |    |    |         |                         |                         |                         |                    |
| 36                           | 12 | 87 | Starter | 7520-12                 | 7521-12                 | 7523-12                 | 1100*              |
| 36                           | 12 | 87 | Adder   | A7520-12                | A7521-12                | A7523-12                | 1100*              |
| 36                           | 18 | 87 | Starter | 7520-18                 | 7521-18                 | 7523-18                 | 1200*              |
| 36                           | 18 | 87 | Adder   | A7520-18                | A7521-18                | A7523-18                | 1200*              |
| 36                           | 24 | 87 | Starter | 7520-24                 | 7521-24                 | 7523-24                 | 1250*              |
| 36                           | 24 | 87 | Adder   | A7520-24                | A7521-24                | A7523-24                | 1250*              |
| 48                           | 12 | 87 | Starter | 7720-12                 | 7721-12                 | 7723-12                 | 750*               |
| 48                           | 12 | 87 | Adder   | A7720-12                | A7721-12                | A7723-12                | 750*               |
| 48                           | 18 | 87 | Starter | 7720-18                 | 7721-18                 | 7723-18                 | 900*               |
| 48                           | 18 | 87 | Adder   | A7720-18                | A7721-18                | A7723-18                | 900*               |
| 48                           | 24 | 87 | Starter | 7720-24                 | 7721-24                 | 7723-24                 | 900*               |
| 48                           | 24 | 87 | Adder   | A7720-24                | A7721-24                | A7723-24                | 900*               |

| Additional Shelves |    | Medium-Duty | Heavy-Duty | Extra Heavy-Duty |           |
|--------------------|----|-------------|------------|------------------|-----------|
| 36                 | 12 | 5135-3612   | 5138-3612  | 5139-3612        | See Above |
| 36                 | 18 | 5135-3618   | 5138-3618  | 5139-3618        | See Above |
| 36                 | 24 | 5135-3624   | 5138-3624  | 5139-3624        | See Above |
| 48                 | 12 | 5135-4812   | 5138-4812  | 5139-4812        | See Above |
| 48                 | 18 | 5135-4818   | 5138-4818  | 5139-4818        | See Above |
| 48                 | 24 | 5135-4824   | 5138-4824  | 5139-4824        | See Above |

\*Shelf capacity based on factor of 1.65.

NOTES: Color for all components 725 Hallowell Gray

CLOSED UNITS: Starter units include two beaded front posts, two angle back posts, one back panel, two side panels and 5-8 shelves. Adder units include one beaded front post, two angle back posts, one back panel assembly, one side panel assembly and 5-8 shelves.



CLOSED TYPE STARTER



CLOSED TYPE ADDER



5 SHELVES



6 SHELVES



8 SHELVES

**STANDARD AND H-POST**

Standard Shelving with Hi-Tech Shelves

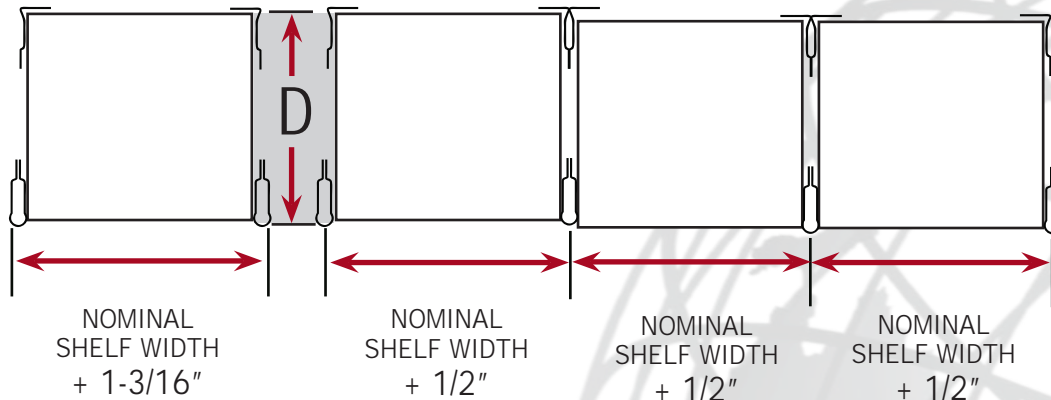

PLUS ADD 3/4" PER ROW  
**FOR "D" - SINGLE FACE** ADD 3/16" TO NOMINAL SHELF DEPTH  
**FOR "D" - DOUBLE FACE** ADD 3/8" TO NOMINAL SHELF DEPTH

H-Post Shelving with Hi-Tech Shelves

See pages 62-63

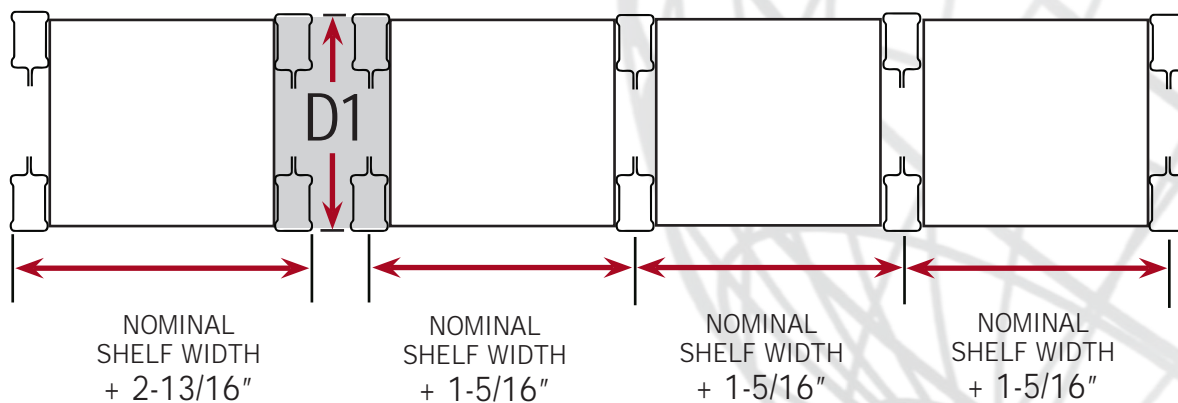

PLUS ADD 1-1/2" PER ROW

**FOR "D1" - SINGLE FACE** ADD 5/16" TO NOMINAL SHELF DEPTH  
**FOR "D1" - DOUBLE FACE** CLOSED MODELS ADD 13/16" TO NOMINAL SHELF DEPTH  
**FOR "D1" - DOUBLE FACE** OPEN MODELS ADD 29/32" TO NOMINAL SELF DEPTH  
**NOTE: SHELF WIDTH IS 5/16" UNDER NOMINAL**

**NOTE:** Width of posts should be added to the nominal shelf width in any floor plan to determine the overall shelving width.  
 Check "D" and "D1" dimensions for depth/creepage.



### 1.65 SAFETY FACTOR

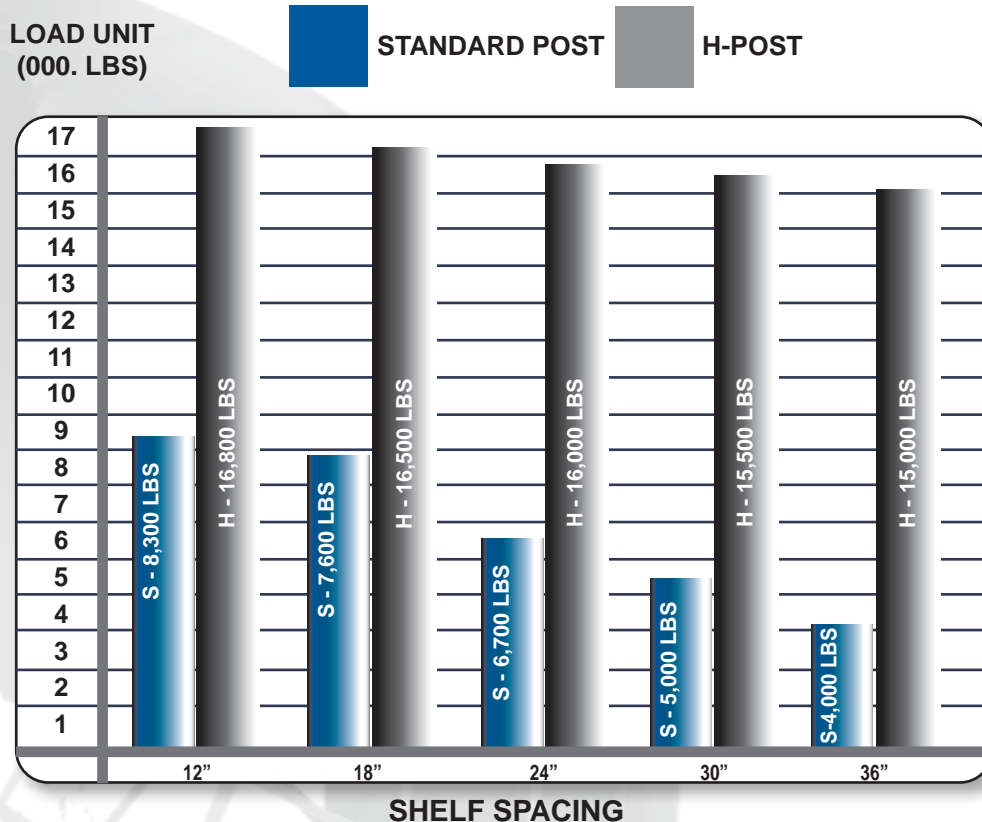

Before selecting type of post, consideration should be given to loads to be carried. Use the formula below to get unit load, then select post type from table.

$$(B-2) \times A = \text{Unit Load}$$

A = Shelf Load  
B = Shelves per unit (includes top and bottom shelves)

**WARNING:**

Use H-Posts for:

- High-rise applications.
- Pass-through applications regardless of load.
- High-density, multi-level applications.

### TYPICAL SWAY BRACE INSTALLATIONS FOR SEISMIC ZONE NO. 0

Standard Shelving (Beaded Front Posts)  
High-Density Shelving (H-Posts)

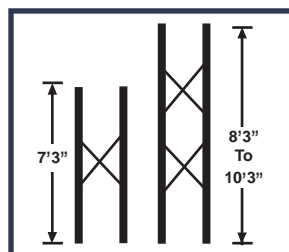

Use of Side Sway Braces (Part No. 5344 – Standard Shelving)

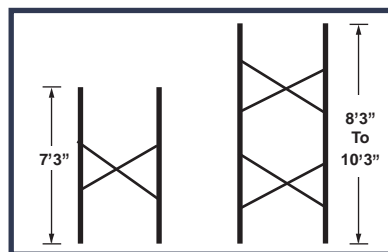

Use of Back Sway Braces (Part No. 5342) for both standard (Part No. 5341–High-Density Shelving) and high density shelving

**NOTES:** 1-When splicing posts for increased heights or for multi-level shelving, use the proper number of braces required for the height of the posts being added.

**Example:** a 10'-3" model increased another 10'-3" in height would require 4 sets of side sway braces and 4 sets of back braces. 2-For additional bracing requirements in Seismic Zones No. 2, 3 and 4, consult the Hollowell Applications Engineering Department.



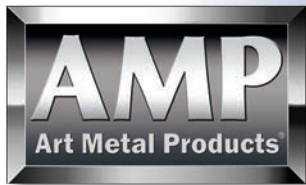

**QUICKSHIP**

## DURATECH™ PASS THRU STEEL SHELVING

### PASS-THRU STEEL SHELVING REQUIRES NO CROSS BRACES UNIQUE DESIGN CREATES A VERY STRONG UNIT!

DuraTech is AMP's newest line of pass-thru steel shelving requiring no cross braces allowing access from all sides while providing the maximum strength, durability and stability needed to handle most industrial applications. DuraTech offers the most versatility and durability for today's modern facilities.

**OUR COMPLETE LINE OF SHELVING IS DESIGNED AND ENGINEERED TO THE HIGHEST STANDARDS.**

*Our Unique Grip Nut Design Creates A Very Strong And Rigid Structure*

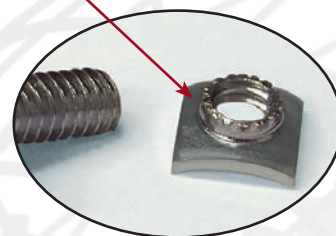

#### FEATURES

- Access from all 4 sides.
- Top and bottom firmly attached with steel-grip nuts for maximum strength
- Available in 5, 7 and 8 shelf models.
- Four angle posts are used per section allowing units to be individually located, bolted side-by-side or bolted back-to-back.
- Each intermediate shelf uses four sturdy and compact clips.
- Clips key firmly into post slots to hold shelves securely in place.
- Provides independent positioning of intermediate shelves on 1-1/2" centers.
- Bottom shelf is positioned to prevent debris from collecting beneath unit.



DARK GRAY (HG)



**360° Access - No Cross Braces  
Creates a more efficient storage system!**



**QUICKSHIP**

**ADJUSTABLE, STRONG,  
SECURE & STABLE**

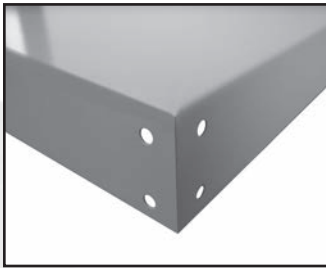
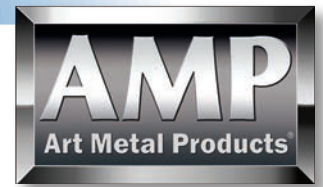

Top and bottom shelves attach with bolts at each corner providing a strong and rigid structure



Bottom shelf is positioned to prevent debris from collecting beneath unit



Top and bottom shelves are triple flanged at all four sides and bolted to angle posts at all four corners for maximum rigidity, durability and stability.



Angle posts are roll formed into a unique angle shape for maximum strength. Leg is punched on 1-1/2" centers to allow independent intermediate shelf adjustment



Intermediate shelves have a tubular flange at the front and rear, and exclusive triple bend sides for added strength.



Compression Shelf Clip for intermediate shelves

**Fully Adjustable Intermediate Shelves with fixed top and bottom for a strong unit That DOES NOT require CROSS Braces**



5-SHELF UNIT  
3-adjustable shelves



7-SHELF UNIT  
5-adjustable shelves



8-SHELF UNIT  
6-adjustable shelves

| W                     | D  | H  | * Capacity Per Shelf | 5-Shelf Catalog No. | 7-Shelf Catalog No. | 8-Shelf Catalog No. |
|-----------------------|----|----|----------------------|---------------------|---------------------|---------------------|
| <b>36" WIDE UNITS</b> |    |    |                      |                     |                     |                     |
| 36                    | 12 | 87 | 800                  | DT5510-12           | DT5512-12           | DT5513-12           |
| 36                    | 18 | 87 | 800                  | DT5510-18           | DT5512-18           | DT5513-18           |
| 36                    | 24 | 87 | 800                  | DT5510-24           | DT5512-24           | DT5513-24           |
| <b>48" WIDE UNITS</b> |    |    |                      |                     |                     |                     |
| 48                    | 12 | 87 | 400                  | DT5710-12           | DT5712-12           | DT5713-12           |
| 48                    | 18 | 87 | 450                  | DT5710-18           | DT5712-18           | DT5713-18           |
| 48                    | 24 | 87 | 500                  | DT5710-24           | DT5712-24           | DT5713-24           |

All Units Include: Four angle posts, two DuraTech bolt-in shelves to be used at unit top and bottom and intermediate adjustable shelves with shelf clips applicable to unit ordered. All DuraTech shelving units are free standing and can be joined end-to-end or back-to-back.

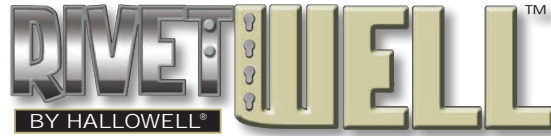

**QUICKSHIP**

**RIVETWELL™  
BOLTLESS SHELVING**

***Boltless shelving is designed to maximize storage space and minimize installation set-up time.***

All components are engineered to attach snugly to one another without the use of loose fasteners. This unique design has rivets which are factory attached to all left-to-right and front-to-back beams. The rivets align with keyhole slots in the vertical posts. Once tapped into place using a standard rubber mallet, the units are tightly assembled providing maximum strength.

Standard units consist of vertical angle posts at the corners, double rivet angle beams at the top and bottom perimeter and single rivet angle beams running left-to-right only at the intermediate levels. Shelves are of standard 5/8" particle board, EZ-Deck steel or wire decking and simply drop into place. Shelf strength can be increased by upgrading to heavy duty beams, adding single rivet beams running front-to-back at the intermediate levels, upgrading to double rivet beams at the full perimeter of the intermediate levels or upgrading all levels to our strongest double rivet channel beams. Optional center supports can be added using supplied hardware to increase decking capacity.



*Double Rivet unit with 5 levels*

The versatility of our Rivetwell boltless shelving system allows you to mix and match components to meet your unique application. From standard storage applications, record storage to automotive tire racks, Rivetwell boltless shelving is your storage solution.



*Single Rivet unit with 5 levels*

*Double Rivet unit with 4 levels*

**EASY ASSEMBLY**

**STOCK COLOR**

729  
TAN (PT)

**COMPONENT SPECIFICATIONS**

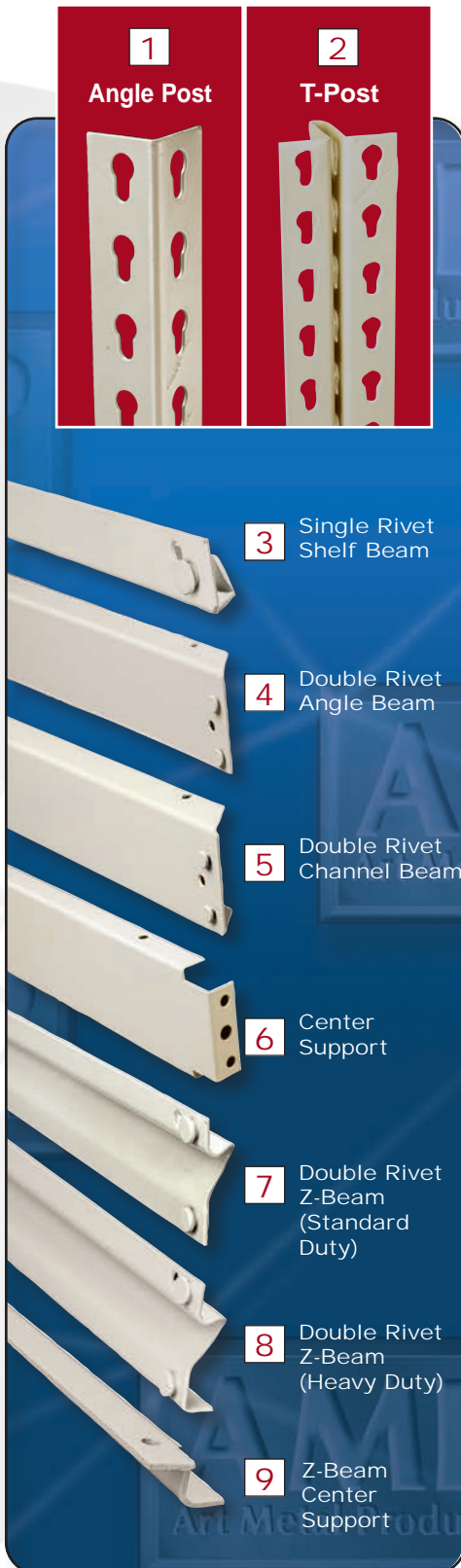

**1 Angle Post (Standard Duty):** 1-1/2" x 1-1/2" x 14 gauge cold rolled steel corner post uprights. Perfect for standard load situations.

**Angle Post (Heavy Duty):** Shall be 1-7/8" x 1-7/8" x 14 gauge cold rolled steel uprights. The choice when heavy duty shelving is required. Perfect for multilevel installations.

**2 T-Post (Standard Duty):** 3" x 1-7/8" x 14 gauge cold rolled steel intermediate uprights.

**T-Post (Heavy Duty):** 3-3/4" x 1-7/8" x 14 gauge cold rolled steel intermediate uprights.

**3 Single Rivet Shelf Beam (Standard Duty):** This 14 gauge low profile standard intermediate level shelf beam is perfect when maximum clear opening is required between shelf levels.

**Single Rivet Shelf Beam (Heavy Duty):** An 11 gauge heavy duty version of our low profile intermediate shelf beam allowing maximum clear opening between shelf levels.

**4 Double Rivet Angle Beam (Standard Duty):** This 16 gauge shelf beam is essential for stability of standard units; therefore, is used on all four sides at the top and bottom levels. Can also be used front and back or on all four sides of intermediate levels to increase unit stability and load capacity.

**Double Rivet Angle Beam (Heavy Duty):** An upgrade to our standard duty double rivet angle beams, our heavy duty double rivet angle beams provide additional unit rigidity and even higher shelf capacity.

**5 Double Rivet Channel Beam:** Maximized left-to-right shelf capacity is achieved using our 14 gauge double rivet channel beams in lieu of double rivet angle beams. These beams cannot be used at the bottom level.

**6 Center Support:** Used to provide additional shelf support front-to-back by bolting between double rivet beams at prepunched locations. Ideal for wider spans.

**7 Double Rivet Z-Beam (Standard Duty):** For 12" thru 60" beams. Used in place of double rivet angle beams to add 1" additional clearance between shelf levels. Allows particle board decking to sit flush with beam. Protects decking edges. When used at bottom level of single rivet units, shelf clearance is increased by 1" at lower level. Standard Z beams are 14 gauge.

**8 Double Rivet Z-Beam (Heavy Duty):** For 69" and 72" beams. Use in place of double rivet angle beams to add 1" additional clearance between shelf levels. Allows particle board decking to sit flush with beam. Protects decking edges. Heavy-Duty Z beams are 14 gauge.

**9 Center Support for Z-Beam:** Used with Z-Beams for front to back decking support. Fabricated of 11 gauge cold rolled steel.

**UNIT GROWTH CHART**

When designing a shelving layout. Unit growth must be considered. To determine the overall dimension of a continuous row of shelving employing T-Posts or Angle Posts with tie plates, refer to the table below.

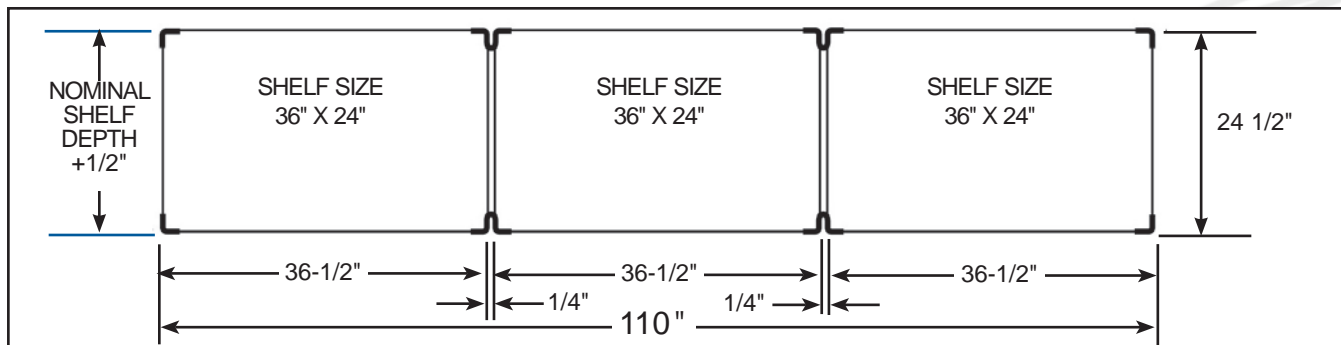

**UNIT CLEAR WIDTH**

Examples below are based on 36" wide shelf.

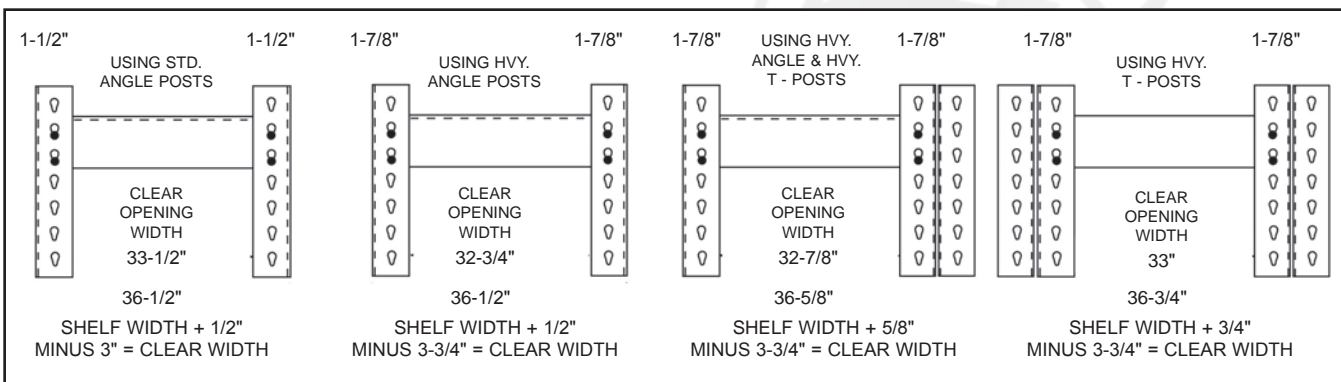

**VERTICAL SHELF CLEARANCE  
FOR SINGLE RIVET UNITS**

This chart depicts shelf clearances for typical rivetwell shelving units with 1-1/2" vertical shelf adjustment

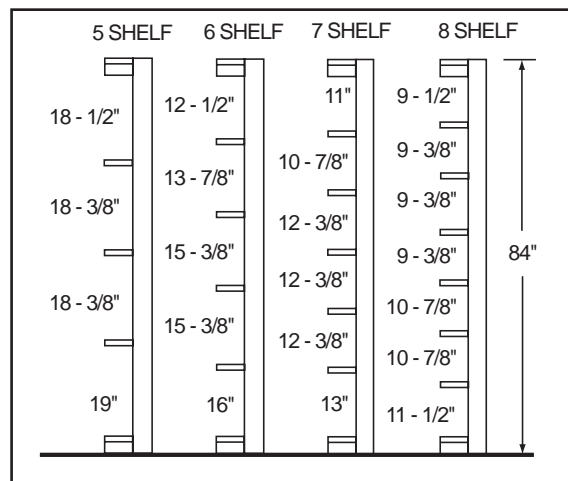

**VERTICAL SHELF CLEARANCE  
FOR DOUBLE RIVET UNITS**

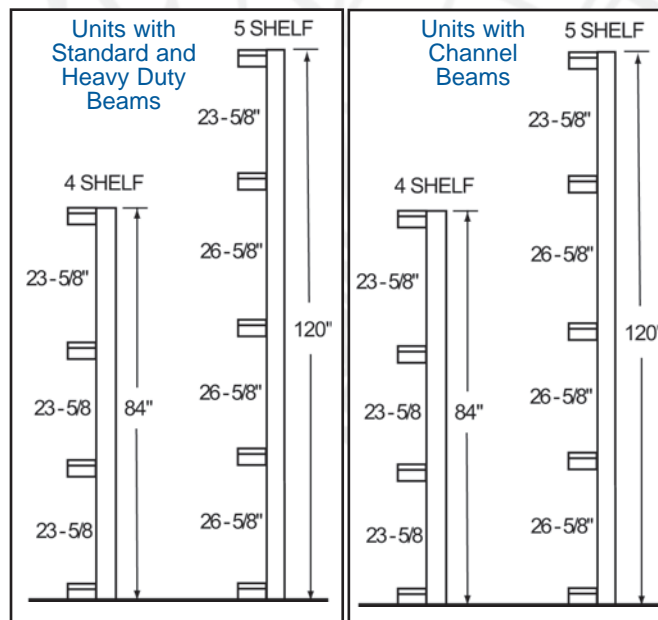

**QUICKSHIP**

# BOLTLESS STEEL SHELVING



RIVETWELL BOLTLESS SHELVING

| SINGLE RIVET UNITS - 84" HIGH |       |                |                   |                        |                |                   |                 |
|-------------------------------|-------|----------------|-------------------|------------------------|----------------|-------------------|-----------------|
| 36" Wide Units                |       |                |                   | 48" Wide Units         |                |                   |                 |
| (Decking not included)        |       |                |                   | (Decking not included) |                |                   |                 |
| Levels                        | Depth | Shelf Capacity | Starter Model No. | Adder Model No.        | Shelf Capacity | Starter Model No. | Adder Model No. |
| 5 Shelf Units                 | 12    | 350            | SRS361284-5S      | SRS361284-5A           | 250            | SRS481284-5S      | SRS481284-5A    |
|                               | 18    | 350            | SRS361884-5S      | SRS361884-5A           | 250            | SRS481884-5S      | SRS481884-5A    |
|                               | 24    | 350            | SRS362484-5S      | SRS362484-5A           | 250            | SRS482484-5S      | SRS482484-5A    |
|                               | 30    | 350            | SRS363084-5S      | SRS363084-5A           | 250            | SRS483084-5S      | SRS483084-5A    |
|                               | 36    | 350            | SRS363684-5S      | SRS363684-5A           | 250            | SRS483684-5S      | SRS483684-5A    |
| 6 Shelf Units                 | 12    | 350            | SRS361284-6S      | SRS361284-6A           | 250            | SRS481284-6S      | SRS481284-6A    |
|                               | 18    | 350            | SRS361884-6S      | SRS361884-6A           | 250            | SRS481884-6S      | SRS481884-6A    |
|                               | 24    | 350            | SRS362484-6S      | SRS362484-6A           | 250            | SRS482484-6S      | SRS482484-6A    |
|                               | 30    | 350            | SRS363084-6S      | SRS363084-6A           | 250            | SRS483084-6S      | SRS483084-6A    |
|                               | 36    | 350            | SRS363684-6S      | SRS363684-6A           | 250            | SRS483684-6S      | SRS483684-6A    |
| 7 Shelf Units                 | 12    | 350            | SRS361284-7S      | SRS361284-7A           | 250            | SRS481284-7S      | SRS481284-7A    |
|                               | 18    | 350            | SRS361884-7S      | SRS361884-7A           | 250            | SRS481884-7S      | SRS481884-7A    |
|                               | 24    | 350            | SRS362484-7S      | SRS362484-7A           | 250            | SRS482484-7S      | SRS482484-7A    |
|                               | 30    | 350            | SRS363084-7S      | SRS363084-7A           | 250            | SRS483084-7S      | SRS483084-7A    |
|                               | 36    | 350            | SRS363684-7S      | SRS363684-7A           | 250            | SRS483684-7S      | SRS483684-7A    |
| 8 Shelf Units                 | 12    | 350            | SRS361284-8S      | SRS361284-8A           | 250            | SRS481284-8S      | SRS481284-8A    |
|                               | 18    | 350            | SRS361884-8S      | SRS361884-8A           | 250            | SRS481884-8S      | SRS481884-8A    |
|                               | 24    | 350            | SRS362484-8S      | SRS362484-8A           | 250            | SRS482484-8S      | SRS482484-8A    |
|                               | 30    | 350            | SRS363084-8S      | SRS363084-8A           | 250            | SRS483084-8S      | SRS483084-8A    |
|                               | 36    | 350            | SRS363684-8S      | SRS363684-8A           | 250            | SRS483684-8S      | SRS483684-8A    |

**STARTER UNITS** consist of four standard angle posts, four left-to-right standard double rivet angle beams, four front-to-back standard double rivet angle beams, two left-to-right standard single rivet beams per intermediate level and two front-to-back standard single rivet beam at one intermediate level only (30" and 36" deep units include two front-to-back single rivet beams at each intermediate level).

**ADDER UNITS** consist of two standard T-Posts, four left-to-right standard double rivet angle beams, two front-to-back standard double rivet angle beam, two left-to-right standard single rivet beam per intermediate level and one front-to-back standard single rivet beam at one intermediate level only (30" and 36" deep units include one front-to-back single rivet beam at each intermediate level).

**PARTICLE BOARD DECKING**

| SIZE      | PART NO. |
|-----------|----------|
| 36" X 12" | HPB3612  |
| 36" X 18" | HPB3618  |
| 36" X 24" | HPB3624  |
| 36" X 30" | HPB3630  |
| 36" X 36" | HPB3636  |
| 48" X 12" | HPB4812  |
| 48" X 18" | HPB4818  |
| 48" X 24" | HPB4824  |
| 48" X 30" | HPB4830  |
| 48" X 36" | HPB4836  |

Be sure to order one each of particle board decking per level. EZ-Deck steel decking can NOT be used on single rivet units.



Standard 5-shelf single rivet unit (order decking separately)

Standard 4-shelf double rivet unit (order decking separately)



729  
TAN (PT)

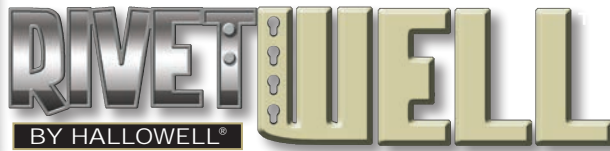

**QUICKSHIP**

**DOUBLE RIVET UNITS - 84" HIGH WITH 4 LEVELS**

|       |            |       | Without Center Support<br>(Decking Not Included) |                   |                 | With Center Support<br>(Decking Not Included) |                   |                 | Decking                |                       |
|-------|------------|-------|--|-------------------|-----------------|---|-------------------|-----------------|------------------------|-----------------------|
| Width | Beam Type  | Depth | Shelf Cap  | Starter Model No. | Adder Model No. | Shelf Cap                                     | Starter Model No. | Adder Model No. | Particle Board Decking | EZ-Deck Steel Decking |
| 48"   | Standard   | 18    | 550  | DRS481884-4S      | DRS481884-4A    | 875   | DRSC481884-4S     | DRSC481884-4A   | HPB4818                | HEZD4818              |
|       |            | 24    | 550  | DRS482484-4S      | DRS482484-4A    | 875   | DRSC482484-4S     | DRSC482484-4A   | HPB4824                | HEZD4824              |
|       | Angle Beam | 30    | 550  | DRS483084-4S      | DRS483084-4A    | 825   | DRSC483084-4S     | DRSC483084-4A   | HPB4830                | HEZD4830              |
|       |            | 36    | 550  | DRS483684-4S      | DRS483684-4A    | 775   | DRSC483684-4S     | DRSC483684-4A   | HPB4836                | HEZD4836              |
|       |            | 48    | 550  | DRS484884-4S      | DRS484884-4A    | 700   | DRSC484884-4S     | DRSC484884-4A   | HPB4848                | HEZD4848              |
| 48"   | Heavy-Duty | 18    | 750  | DRH481884-4S      | DRH481884-4A    | 1400  | DRHC481884-4S     | DRHC481884-4A   | HPB4818                | HEZD4818              |
|       |            | 24    | 750  | DRH482484-4S      | DRH482484-4A    | 1400  | DRHC482484-4S     | DRHC482484-4A   | HPB4824                | HEZD4824              |
|       | Angle      | 30    | 750  | DRH483084-4S      | DRH483084-4A    | 1310  | DRHC483084-4S     | DRHC483084-4A   | HPB4830                | HEZD4830              |
|       |            | 36    | 750  | DRH483684-4S      | DRH483684-4A    | 1220  | DRHC483684-4S     | DRHC483684-4A   | HPB4836                | HEZD4836              |
|       |            | 48    | 750  | DRH484884-4S      | DRH484884-4A    | 1125  | DRHC484884-4S     | DRHC484884-4A   | HPB4848                | HEZD4848              |
| 60"   | Heavy-Duty | 18    | 600  | DRH601884-4S      | DRH601884-4A    | 1200  | DRHC601884-4S     | DRHC601884-4A   | HPB6018                | HEZD6018              |
|       |            | 24    | 600  | DRH602484-4S      | DRH602484-4A    | 1200  | DRHC602484-4S     | DRHC602484-4A   | HPB6024                | HEZD6024              |
|       | Angle Beam | 30    | 600  | DRH603084-4S      | DRH603084-4A    | 1200  | DRHC603084-4S     | DRHC603084-4A   | HPB6030                | HEZD6030              |
|       |            | 36    | 600  | DRH603684-4S      | DRH603684-4A    | 1200  | DRHC603684-4S     | DRHC603684-4A   | HPB6036                | HEZD6036              |
|       |            | 48    | 600  | DRH604884-4S      | DRH604884-4A    | 1200  | DRHC604884-4S     | DRHC604884-4A   | HPB6048                | HEZD6048              |
| 60"   | Channel    | 18    | -  | -                 | -               | 2000  | DRCC601884-4S     | DRCC601884-4A   | HPB6018                | HEZD6018              |
|       |            | 24    | -  | -                 | -               | 2000  | DRCC602484-4S     | DRCC602484-4A   | HPB6024                | HEZD6024              |
|       | Beam       | 30    | -  | -                 | -               | 2000  | DRCC603084-4S     | DRCC603084-4A   | HPB6030                | HEZD6030              |
|       |            | 36    | -  | -                 | -               | 2000  | DRCC603684-4S     | DRCC603684-4A   | HPB6036                | HEZD6036              |
|       |            | 48    | -  | -                 | -               | 2000  | DRCC604884-4S     | DRCC604884-4A   | HPB6048                | HEZD6048              |
| 72"   | Heavy-Duty | 18    | 500  | DRH721884-4S      | DRH721884-4A    | 1000  | DRHC721884-4S     | DRHC721884-4A   | HPB7218                | HEZD7218              |
|       |            | 24    | 500  | DRH722484-4S      | DRH722484-4A    | 1000  | DRHC722484-4S     | DRHC722484-4A   | HPB7224                | HEZD7224              |
|       | Angle Beam | 30    | 500  | DRH723084-4S      | DRH723084-4A    | 1000  | DRHC723084-4S     | DRHC723084-4A   | HPB7230                | HEZD7230              |
|       |            | 36    | 500  | DRH723684-4S      | DRH723684-4A    | 1000  | DRHC723684-4S     | DRHC723684-4A   | HPB7236                | HEZD7236              |
|       |            | 48    | 500  | DRH724884-4S      | DRH724884-4A    | 1000  | DRHC724884-4S     | DRHC724884-4A   | HPB7248                | HEZD7248              |
| 72"   | Channel    | 18    | -  | -                 | -               | 1850  | DRCC721884-4S     | DRCC721884-4A   | HPB7218                | HEZD7218              |
|       |            | 24    | -  | -                 | -               | 1850  | DRCC722484-4S     | DRCC722484-4A   | HPB7224                | HEZD7224              |
|       | Beam       | 30    | -  | -                 | -               | 1850  | DRCC723084-4S     | DRCC723084-4A   | HPB7230                | HEZD7230              |
|       |            | 36    | -  | -                 | -               | 1850  | DRCC723684-4S     | DRCC723684-4A   | HPB7236                | HEZD7236              |
|       |            | 48    | -  | -                 | -               | 1850  | DRCC724884-4S     | DRCC724884-4A   | HPB7248                | HEZD7248              |
| 96"   | Heavy-Duty | 18    | -  | -                 | -               | 620   | DRHC961884-4S     | DRHC961884-4A   | HPB9618                | HEZD9618              |
|       |            | 24    | -  | -                 | -               | 620   | DRHC962484-4S     | DRHC962484-4A   | HPB9624                | HEZD9624              |
|       | Angle Beam | 30    | -  | -                 | -               | 620   | DRHC963084-4S     | DRHC963084-4A   | HPB9630                | HEZD9630              |
|       |            | 36    | -  | -                 | -               | 620   | DRHC963684-4S     | DRHC963684-4A   | HPB9636                | HEZD9636              |
|       |            | 48    | -  | -                 | -               | 620   | DRHC964884-4S     | DRHC964884-4A   | HPB9648                | HEZD9648              |
| 96"   | Channel    | 18    | -  | -                 | -               | 1400  | DRCC961884-4S     | DRCC961884-4A   | HPB9618                | HEZD9618              |
|       |            | 24    | -  | -                 | -               | 1400  | DRCC962484-4S     | DRCC962484-4A   | HPB9624                | HEZD9624              |
|       | Beam       | 30    | -  | -                 | -               | 1400  | DRCC963084-4S     | DRCC963084-4A   | HPB9630                | HEZD9630              |
|       |            | 36    | -  | -                 | -               | 1400  | DRCC963684-4S     | DRCC963684-4A   | HPB9636                | HEZD9636              |
|       |            | 48    | -  | -                 | -               | 1400  | DRCC964884-4S     | DRCC964884-4A   | HPB9648                | HEZD9648              |

**DOUBLE RIVET UNITS - 120" HIGH WITH 5 LEVELS**

|     |                          |    |     |               |               |      |                |                |         |          |
|-----|--------------------------|----|-----|---------------|---------------|------|----------------|----------------|---------|----------|
| 72" | Heavy-Duty<br>Angle Beam | 30 | 500 | DRH7230120-5S | DRH7230120-5A | 1000 | DRHC7230120-5S | DRHC7230120-5A | HPB7230 | HEZD7230 |
|     |                          | 36 | 500 | DRH7236120-5S | DRH7236120-5A | 1000 | DRHC7236120-5S | DRHC7236120-5A | HPB7236 | HEZD7236 |
|     |                          | 48 | 500 | DRH7248120-5S | DRH7248120-5A | 1000 | DRHC7248120-5S | DRHC7248120-5A | HPB7248 | HEZD7248 |
| 72" | Channel<br>Beam          | 30 | -   | -             | -             | 1490 | DRCC7230120-5S | DRCC7230120-5A | HPB7230 | HEZD7230 |
|     |                          | 36 | -   | -             | -             | 1490 | DRCC7236120-5S | DRCC7236120-5A | HPB7236 | HEZD7236 |
|     |                          | 48 | -   | -             | -             | 1490 | DRCC7248120-5S | DRCC7248120-5A | HPB7248 | HEZD7248 |
| 96" | Heavy-Duty<br>Angle Beam | 30 | -   | -             | -             | 620  | DRHC9630120-5S | DRHC9630120-5A | HPB9630 | HEZD9630 |
|     |                          | 36 | -   | -             | -             | 620  | DRHC9636120-5S | DRHC9636120-5A | HPB9636 | HEZD9636 |
|     |                          | 48 | -   | -             | -             | 620  | DRHC9648120-5S | DRHC9648120-5A | HPB9648 | HEZD9648 |
| 96" | Channel<br>Beam          | 30 | -   | -             | -             | 1400 | DRCC9630120-5S | DRCC9630120-5A | HPB9630 | HEZD9630 |
|     |                          | 36 | -   | -             | -             | 1400 | DRCC9636120-5S | DRCC9636120-5A | HPB9636 | HEZD9636 |
|     |                          | 48 | -   | -             | -             | 1400 | DRCC9648120-5S | DRCC9648120-5A | HPB9648 | HEZD9648 |

**Starter units** consist of four standard angle posts, \*two left-to-right standard double rivet angle/channel beams per level and two front-to-back standard double rivet angle beams per level.

**Adder units** consist of two standard T-Posts, \*two left-to-right standard double rivet angle/channel beams per level and two front-to-back standard double rivet angle beams per level. \*Channel beam units are provided with left-to-right double rivet angle beams at bottom level.



| RECORD STORAGE UNITS |       |        |        |              |                   |                 |                        |                       |
|----------------------|-------|--------|--------|--------------|-------------------|-----------------|------------------------|-----------------------|
| Width                | Depth | Height | Levels | No. of boxes | Starter Model No. | Adder Model No. | Particle Board Decking | EZ-Deck Steel Decking |
| 42"                  | 15"   | 60"    | 3      | 18           | RS421560-3S       | RS421560-3A     | HPB4215                | HEZD4215              |
|                      | 30"   | 60"    | 3      | 36           | RS423060-3S       | RS423060-3A     | HPB4230                | HEZD4230              |
| 69"                  | 15"   | 60"    | 3      | 30           | RS691560-3S       | RS691560-3A     | HPB6915                | HEZD6915              |
|                      | 30"   | 60"    | 3      | 60           | RS693060-3S       | RS693060-3A     | HPB6930                | HEZD6930              |
| 42"                  | 15"   | 84"    | 4      | 24           | RS421584-4S       | RS421584-4A     | HPB4215                | HEZD4215              |
|                      | 30"   | 84"    | 4      | 48           | RS423084-4S       | RS423084-4A     | HPB4230                | HEZD4230              |
| 69"                  | 15"   | 84"    | 4      | 40           | RS691584-4S       | RS691584-4A     | HPB6915                | HEZD6915              |
|                      | 30"   | 84"    | 4      | 80           | RS693084-4S       | RS693084-4A     | HPB6930                | HEZD6930              |
| 42"                  | 15"   | 108"   | 5      | 30           | RS4215108-5S      | RS4215108-5A    | HPB4215                | HEZD4215              |
|                      | 30"   | 108"   | 5      | 60           | RS4230108-5S      | RS4230108-5A    | HPB4230                | HEZD4230              |
| 69"                  | 15"   | 108"   | 5      | 50           | RS6915108-5S      | RS6915108-5A    | HPB6915                | HEZD6915              |
|                      | 30"   | 108"   | 5      | 100          | RS6930108-5S      | RS6930108-5A    | HPB6930                | HEZD6930              |

Be sure to order one each of particle board or EZ-Deck steel decking per level. The above units do not include record storage boxes.

**HALLOWELL RECORD STORAGE BOXES** are 12" w x 15" d x 10" h and are constructed of 200# test white corrugated. Includes double thickness bottoms and reinforced carry handles. Must be ordered in lots of 20.



**RECORD STORAGE BOXES**

|             |                 |
|-------------|-----------------|
| Catalog No. | Qty. Per Carton |
| HRSB        | 20              |

**Access Unit From Front or Back!**



Record Storage Unit with 4 levels (80 Box unit)



729 TAN

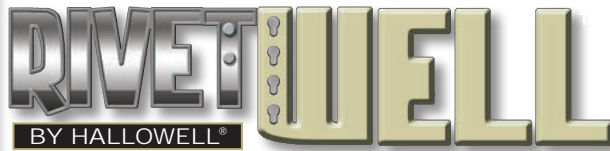

**QUICKSHIP**

**PARTICLE BOARD AND EZ-DECK™ CAPACITY RATINGS**

Recommended safe use load table for 5/8" particle board and EZ-Deck steel decking allowable uniformly distributed static live loads for deck material

| Size (inches) W x D | Particle Board Decking | EZ-Deck Steel Decking | 2 SIDES SUPPORTED |            | 4 SIDES SUPPORTED |            | 4 SIDES + CENTER SUPPORTED |            | 4 SIDES + 2 CENTER SUPPORTED |            |
|---------------------|------------------------|-----------------------|-------------------|------------|-------------------|------------|----------------------------|------------|------------------------------|------------|
|                     |                        |                       | LOAD (lbs.)       | DEFL (ins) | LOAD (lbs.)       | DEFL (ins) | LOAD (lbs.)                | DEFL (ins) | LOAD (lbs.)                  | DEFL (ins) |
| 36x12               | HPB3612                | HEZD3612              | 425               | 0.06       | 675               | 0.08       |                            |            |                              |            |
| 36x18               | HPB3618                | HEZD3618              | 400               | 0.17       | 550               | 0.18       |                            |            |                              |            |
| 36x24               | HPB3624                | HEZD3624              | 305               | 0.30       | 435               | 0.23       |                            |            |                              |            |
| 36x30               | HPB3630                | HEZD3630              | 250               | 0.47       | 385               | 0.32       |                            |            |                              |            |
| 36x36               | HPB3636                | HEZD3636              | 150               | 0.50       | 180               | 0.39       |                            |            |                              |            |
| 42x12               | HPB4212                | HEZD4212              | 490               | 0.06       | 755               | 0.08       |                            |            |                              |            |
| 42x18               | HPB4218                | HEZD4218              | 460               | 0.17       | 600               | 0.18       |                            |            |                              |            |
| 42x24               | HPB4224                | HEZD4224              | 355               | 0.30       | 500               | 0.29       |                            |            |                              |            |
| 42x30               | HPB4230                | HEZD4230              | 300               | 0.47       | 410               | 0.36       |                            |            |                              |            |
| 42x36               | HPB4236                | HEZD4236              | 175               | 0.50       | 385               | 0.45       |                            |            |                              |            |
| 48x12               | HPB4812                | HEZD4812              | 560               | 0.06       | 850               | 0.08       | 1160                       | 0.08       |                              |            |
| 48x18               | HPB4818                | HEZD4818              | 525               | 0.17       | 635               | 0.18       | 770                        | 0.10       |                              |            |
| 48x24               | HPB4824                | HEZD4824              | 405               | 0.30       | 530               | 0.30       | 700                        | 0.11       |                              |            |
| 48x30               | HPB4830                | HEZD4830              | 325               | 0.47       | 440               | 0.40       | 705                        | 0.12       |                              |            |
| 48x36               | HPB4836                | HEZD4836              | 200               | 0.50       | 400               | 0.50       | 755                        | 0.12       |                              |            |
| 48x48               | HPB4848                | HEZD4848              | 85                | 0.50       | 275               | 0.50       | 920                        | 0.13       |                              |            |
| 60x18               | HPB6018                | HEZD6018              | 660               | 0.17       | 735               | 0.18       | 835                        | 0.12       | 1140                         | 0.08       |
| 60x24               | HPB6024                | HEZD6024              | 505               | 0.30       | 615               | 0.32       | 700                        | 0.15       | 1180                         | 0.10       |
| 60x30               | HPB6030                | HEZD6030              | 410               | 0.47       | 520               | 0.46       | 650                        | 0.16       | 1324                         | 0.11       |
| 60x36               | HPB6036                | HEZD6036              | 250               | 0.50       | 380               | 0.50       | 665                        | 0.17       | 1520                         | 0.12       |
| 60x48               | HPB6048                | HEZD6048              | 105               | 0.50       | 230               | 0.50       | 750                        | 0.18       | 2000                         | 0.14       |
| 69x15               | HPB6915                | HEZD6915              | 900               | 0.11       | 950               | 0.12       | 1150                       | 0.12       | 1250                         | 0.11       |
| 69x30               | HPB6930                | HEZD6930              | 470               | 0.50       | 600               | 0.50       | 670                        | 0.20       | 1220                         | 0.13       |
| 72x18               | HPB7218                | HEZD7218              | 800               | 0.17       | 850               | 0.17       | 1000                       | 0.15       | 1200                         | 0.10       |
| 72x24               | HPB7224                | HEZD7224              | 605               | 0.30       | 680               | 0.31       | 770                        | 0.19       | 1135                         | 0.12       |
| 72x30               | HPB7230                | HEZD7230              | 500               | 0.47       | 610               | 0.50       | 680                        | 0.21       | 1200                         | 0.14       |
| 72x36               | HPB7236                | HEZD7236              | 300               | 0.50       | 390               | 0.50       | 655                        | 0.23       | 1325                         | 0.16       |
| 72x48               | HPB7248                | HEZD7248              | 130               | 0.50       | 215               | 0.50       | 685                        | 0.25       | 1670                         | 0.18       |
| 84x24               | HPB8424                | HEZD8424              | 705               | 0.30       | 765               | 0.31       | 870                        | 0.23       | 1150                         | 0.15       |
| 84x30               | HPB8430                | HEZD8430              | 570               | 0.47       | 650               | 0.49       | 735                        | 0.27       | 1150                         | 0.18       |
| 84x36               | HPB8436                | HEZD8436              | 355               | 0.50       | 415               | 0.50       | 670                        | 0.29       | 1210                         | 0.20       |
| 84x48               | HPB8448                | HEZD8448              | 150               | 0.50       | 215               | 0.50       | 660                        | 0.33       | 1460                         | 0.23       |
| 96x18               | HPB9618                | HEZD9618              | 1050              | 0.17       | 1115              | 0.17       | 1300                       | 0.18       | 1500                         | 0.15       |
| 96x24               | HPB9624                | HEZD9624              | 810               | 0.30       | 850               | 0.31       | 1000                       | 0.26       | 1200                         | 0.18       |
| 96x30               | HPB9630                | HEZD9630              | 655               | 0.47       | 710               | 0.49       | 800                        | 0.32       | 1180                         | 0.20       |
| 96x36               | HPB9636                | HEZD9636              | 405               | 0.50       | 450               | 0.50       | 710                        | 0.36       | 1150                         | 0.24       |
| 96x48               | HPB9648                | HEZD9648              | 170               | 0.50       | 200               | 0.50       | 650                        | 0.41       | 1325                         | 0.28       |

| Wire Decking | Size (inches) W x D | Wire Supports | Capacity (lbs) |
|--------------|---------------------|---------------|----------------|
| HWD3618      | 36" x 18"           | 4             | 725            |
| HWD3624      | 36" x 24"           | 4             | 605            |
| HWD3630      | 36" x 30"           | 4             | 485            |
| HWD3636      | 36" x 36"           | 4             | 455            |
| HWD3648      | 36" x 48"           | 4             | 300            |
| HWD4818      | 48" x 18"           | 5             | 725            |
| HWD4824      | 48" x 24"           | 5             | 605            |
| HWD4830      | 48" x 30"           | 5             | 485            |
| HWD4836      | 48" x 36"           | 5             | 455            |
| HWD4848      | 48" x 48"           | 5             | 300            |
| HWD6018      | 60" x 18"           | 6             | 725            |
| HWD6024      | 60" x 24"           | 6             | 605            |
| HWD6030      | 60" x 30"           | 6             | 485            |
| HWD6036      | 60" x 36"           | 6             | 455            |
| HWD6048      | 60" x 48"           | 6             | 300            |

All wire decks are powder coated gray.

All sizes measure 1/8" short of nominal dimension in both directions.

**NOTE: The above load chart refers to the deck materials only. Particle board decking is 5/8" industrial grade type 1-M-2.**

EZ-Deck steel decking is 22 gauge galvanized sheet steel fabricated in 6" deep channel planks (models listed above include multiple planks to meet unit depth). 15" deep Ez-Deck will be shipped in two (2) 7 1/2" deep planks. The allowable shelf load capacity may be reduced due to allowable post and / or beam capacities. Specific deflection limits may also reduce the shelf load capacity.

**NOTE: EZ-Deck must be center supported on units 48" wide and wider. EZ-Deck steel decking can NOT be used on single rivet units.**

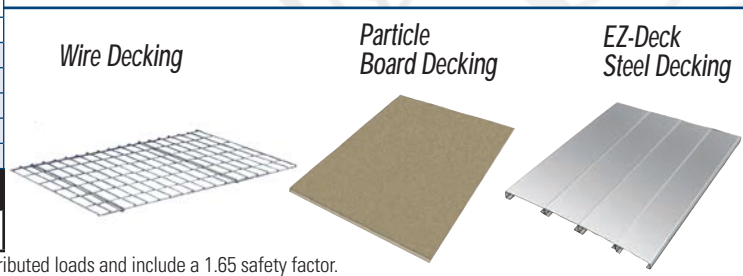

Capacities are based on evenly distributed loads and include a 1.65 safety factor.

**QUICKSHIP**

# RIVETWELL™ TIRE, MUFFLER AND TAILPIPE STORAGE UNITS

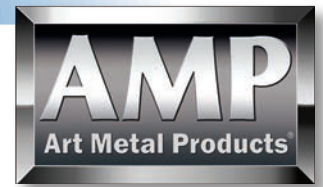

RIVETWELL™ BOLTLLESS SHELVING

| TIRE STORAGE RACKS |       |        |        |                |                   |                 |
|--------------------|-------|--------|--------|----------------|-------------------|-----------------|
| Width              | Depth | Height | Levels | *Tire Capacity | Starter Model No. | Adder Model No. |
| <b>SINGLE ROW</b>  |       |        |        |                |                   |                 |
| 60"                | 21"   | 84"    | 3      | 24             | TSS602184-3S      | TSS602184-3A    |
|                    | 21"   | 120"   | 4      | 32             | TSS6021120-4S     | TSS6021120-4A   |
|                    | 21"   | 144"   | 5      | 40             | TSS6021144-5S     | TSS6021144-5A   |
| <b>DOUBLE ROW</b>  |       |        |        |                |                   |                 |
| 60"                | 21"   | 84"    | 3      | 48             | TSD602184-3S      | TSD602184-3A    |
|                    | 21"   | 120"   | 4      | 64             | TSD6021120-4S     | TSD6021120-4A   |
|                    | 21"   | 144"   | 5      | 80             | TSD6021144-5S     | TSD6021144-5A   |

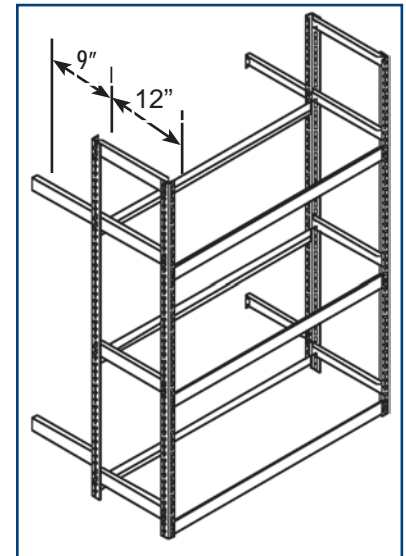

Tire Storage Rack

(\*)Based on average passenger tire (\*\*) Supplied with heavy-duty posts

NOTE: 144" high units are supplied with two 6' posts spliced to achieve 12' height. 192" high units are supplied with two 8' posts spliced to achieve 16' height. For additional configurations, please contact our inside sales department.

| MUFFLER STORAGE UNITS |       |        |        |                   |                 | Particle Board Decking |          |
|-----------------------|-------|--------|--------|-------------------|-----------------|------------------------|----------|
| Width                 | Depth | Height | Levels | Starter Model No. | Adder Model No. | Size                   | Part No. |
| 48"                   | 36"   | 84"    | 5      | MS483684-5S       | MS483684-5A     | 48" X 36"              | HPB4836  |
| 96"                   | 36"   | 84"    | 5      | MS963684-5S       | MS963684-5A     | 96" X 36"              | HPB9636  |

Be sure to order one each of particle board decking per level.

| HANGING TAILPIPE RACK |       |        |                   |
|-----------------------|-------|--------|-------------------|
| Width                 | Depth | Height | Starter Model No. |
| 48"                   | 18"   | 120"   | HTP4818120        |
| 96"                   | 18"   | 120"   | HTP9618120        |

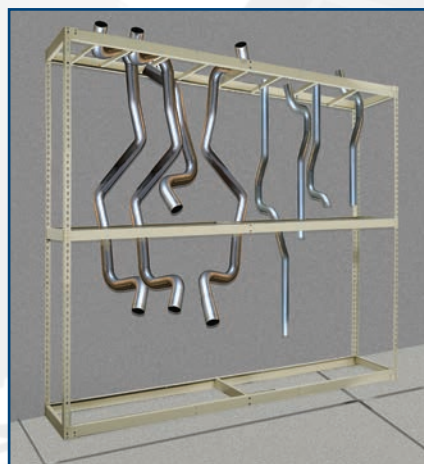

Hanging Tailpipe Rack



Tire Rack

**STOCK COLOR**

729 TAN (PT)



Muffler Storage Rack



**QUICKSHIP**

## COMMERCIAL KD CABINETS

# 400 SERIES

**2 YEAR WARRANTY** **KD KNOCK DOWN ASSEMBLY**

*Functional Durable Adaptable*



Stationary Combination  
Shown with  
Solid Doors



Mobile Storage  
Shown with  
Ventilated Doors



Stationary Wardrobe  
Shown with  
Safety-View Doors



Wall Mount



### CONFIGURATIONS:

- Wall Mount.
- Storage (includes 4 adjustable shelves).
- Wardrobe (includes 1 shelf and coat rod).
- Combination (includes 1 full width shelf, 3 half width shelves and a half width coat rod).

### DOOR OPTIONS:

- Solid.
- Safety-View (includes polycarbonate panels in door).
- Ventilated (includes expanded metal panels in door).



### GENERAL SPECIFICATIONS

- All components precision engineered with no bolt heads showing on front and side panels.
- Body and shelves fabricated from 22 gauge steel.
- Shelves easily adjust up or down in 2" increments. Triple flanged shelf front for added strength (capacity up to 200 lbs).
- Reinforced doors swing a full 180°.
- Doors are factory-hung in 16 gauge frames ensuring proper performance.
- 16 gauge continuous hinges.
- Corner foot gussets provide added rigidity and stability (replaced by mounting plates on mobile units).
- Mobile units include four heavy-duty locking swivel casters.
- Positive three-point locking (top, center and bottom) for secure locking (single cam only for 16" wide wall-mount cabinets).
- Plated locking handle has built-in cylinder key lock (keys included).



| 400 SERIES INDUSTRIAL STRENGTH STEEL CABINETS |       |       |        |                    |                   |                 |
|---|-------|-------|--------|--------------------|-------------------|-----------------|
| Description                                   | Width | Depth | Height | Knock-Down Cat No. | Assembled Cat No. | Color Selection |
| <b>SOLID DOOR CABINETS</b>                    |       |       |        |                    |                   |                 |
| Wall Mount, Storage                           | 16    | 12    | 26     | 405-1626           | 405-1626A         | ME, HG, PT      |
| Wall Mount, Storage                           | 30    | 12    | 26     | 405-3026           | 405-3026A         | ME, HG, PT      |
| Wall Mount, Storage                           | 36    | 12    | 30     | 405-3630           | 405-3630A         | ME, HG, PT      |
| Slimline, Storage                             | 18    | 18    | 42     | 410S181842         | 410S181842A       | PT              |
| Slimline, Storage                             | 18    | 18    | 66     | 410S181866         | 410S181866A       | PT              |
| Slimline, Storage                             | 30    | 15    | 66     | 410S301566         | 410S301566A       | PT              |
| Stationary, Storage                           | 36    | 18    | 72     | 415S18             | 415S18A           | ME, HG, PT      |
| Stationary, Storage                           | 36    | 24    | 72     | 415S24             | 415S24A           | ME, HG, PT      |
| Stationary, Storage                           | 48    | 18    | 72     | 425S18             | 425S18A           | ME, HG, PT      |
| Stationary, Storage                           | 48    | 24    | 72     | 425S24             | 425S24A           | ME, HG, PT      |
| Stationary, Wardrobe                          | 36    | 18    | 72     | 435W18             | 435W18A           | ME, HG, PT      |
| Stationary, Wardrobe                          | 36    | 24    | 72     | 435W24             | 435W24A           | ME, HG, PT      |
| Stationary, Wardrobe                          | 48    | 18    | 72     | 445W18             | 445W18A           | ME, HG, PT      |
| Stationary, Wardrobe                          | 48    | 24    | 72     | 445W24             | 445W24A           | ME, HG, PT      |
| Stationary, Combination                       | 36    | 18    | 72     | 455C18             | 455C18A           | ME, HG, PT      |
| Stationary, Combination                       | 36    | 24    | 72     | 455C24             | 455C24A           | ME, HG, PT      |
| Stationary, Combination                       | 48    | 18    | 72     | 465C18             | 465C18A           | ME, HG, PT      |
| Stationary, Combination                       | 48    | 24    | 72     | 465C24             | 465C24A           | ME, HG, PT      |
| Mobile, Storage                               | 36    | 24    | 72     | 415S24M            | 415S24MA          | ME, HG, PT      |
| Mobile, Storage                               | 48    | 24    | 72     | 425S24M            | 425S24MA          | ME, HG, PT      |
| <b>SAFETY VIEW DOOR CABINETS</b>              |       |       |        |                    |                   |                 |
| Wall Mount, Storage                           | 16    | 12    | 26     | 405-1626SV         | 405-1626SVA       | ME, HG, PT      |
| Wall Mount, Storage                           | 30    | 12    | 26     | 405-3026SV         | 405-3026SVA       | ME, HG, PT      |
| Wall Mount, Storage                           | 36    | 12    | 30     | 405-3630SV         | 405-3630SVA       | ME, HG, PT      |
| Stationary, Storage                           | 36    | 18    | 72     | 415S18SV           | 415S18SVA         | ME, HG, PT      |
| Stationary, Storage                           | 36    | 24    | 72     | 415S24SV           | 415S24SVA         | ME, HG, PT      |
| Stationary, Storage                           | 48    | 18    | 72     | 425S18SV           | 425S18SVA         | ME, HG, PT      |
| Stationary, Storage                           | 48    | 24    | 72     | 425S24SV           | 425S24SVA         | ME, HG, PT      |
| Stationary, Wardrobe                          | 36    | 18    | 72     | 435W18SV           | 435W18SVA         | ME, HG, PT      |
| Stationary, Wardrobe                          | 36    | 24    | 72     | 435W24SV           | 435W24SVA         | ME, HG, PT      |
| Stationary, Wardrobe                          | 48    | 18    | 72     | 445W18SV           | 445W18SVA         | ME, HG, PT      |
| Stationary, Wardrobe                          | 48    | 24    | 72     | 445W24SV           | 445W24SVA         | ME, HG, PT      |
| Stationary, Combination                       | 36    | 18    | 72     | 455C18SV           | 455C18SVA         | ME, HG, PT      |
| Stationary, Combination                       | 36    | 24    | 72     | 455C24SV           | 455C24SVA         | ME, HG, PT      |
| Stationary, Combination                       | 48    | 18    | 72     | 465C18SV           | 465C18SVA         | ME, HG, PT      |
| Stationary, Combination                       | 48    | 24    | 72     | 465C24SV           | 465C24SVA         | ME, HG, PT      |
| Mobile, Storage                               | 36    | 24    | 72     | 415S24SVM          | 415S24SVMMA       | ME, HG, PT      |
| Mobile, Storage                               | 48    | 24    | 72     | 425S24SVM          | 425S24SVMMA       | ME, HG, PT      |
| <b>VENTILATED DOOR CABINETS</b>               |       |       |        |                    |                   |                 |
| Stationary, Storage                           | 36    | 18    | 72     | 415S18EV           | 415S18EVA         | ME, HG, PT      |
| Stationary, Storage                           | 36    | 24    | 72     | 415S24EV           | 415S24EVA         | ME, HG, PT      |
| Stationary, Storage                           | 48    | 18    | 72     | 425S18EV           | 425S18EVA         | ME, HG, PT      |
| Stationary, Storage                           | 48    | 24    | 72     | 425S24EV           | 425S24EVA         | ME, HG, PT      |
| Stationary, Wardrobe                          | 36    | 18    | 72     | 435W18EV           | 435W18EVA         | ME, HG, PT      |
| Stationary, Wardrobe                          | 36    | 24    | 72     | 435W24EV           | 435W24EVA         | ME, HG, PT      |
| Stationary, Wardrobe                          | 48    | 18    | 72     | 445W18EV           | 445W18EVA         | ME, HG, PT      |
| Stationary, Wardrobe                          | 48    | 24    | 72     | 445W24EV           | 445W24EVA         | ME, HG, PT      |
| Stationary, Combination                       | 36    | 18    | 72     | 455C18EV           | 455C18EVA         | ME, HG, PT      |
| Stationary, Combination                       | 36    | 24    | 72     | 455C24EV           | 455C24EVA         | ME, HG, PT      |
| Stationary, Combination                       | 48    | 18    | 72     | 465C18EV           | 465C18EVA         | ME, HG, PT      |
| Stationary, Combination                       | 48    | 24    | 72     | 465C24EV           | 465C24EVA         | ME, HG, PT      |
| Mobile, Storage                               | 36    | 24    | 72     | 415S24EVM          | 415S24EVMMA       | ME, HG, PT      |
| Mobile, Storage                               | 48    | 24    | 72     | 425S24EVM          | 425S24EVMMA       | ME, HG, PT      |

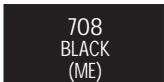



**QUICKSHIP**

## INDUSTRIAL STRENGTH STEEL CABINETS

# 800 SERIES

**2 YEAR WARRANTY** **KD KNOCK DOWN ASSEMBLY**

### Industrial Strength Storage



Stationary Wardrobe  
Shown with  
Solid Doors



Mobile Storage  
Shown with  
Safety-View Doors



Stationary Wardrobe  
Shown with  
Ventilated Doors



Stationary Combination  
Shown with  
Safety-View Doors

#### CONFIGURATIONS:

- Storage (includes 4 adjustable shelves).
- Wardrobe (includes 1 shelf and coat rod).
- Combination (includes 1 full width shelf, 3 half width shelves and a half width coat rod).

#### DOOR OPTIONS:

- Solid.
- Safety-View (includes polycarbonate panels in door)
- Ventilated (includes expanded metal panels in door)



#### GENERAL SPECIFICATIONS

- All components precision engineered with nobolt heads showing on front and side panels.
- 20 gauge body and 22 gauge shelves provide strength and durability.
- Shelves easily adjust up or down in 2" increments. Triple flanged shelf front for added strength (capacity up to 250 lbs).
- Reinforced doors swing a full 180°.
- Doors are factory-hung in 16 gauge frames ensuring proper performance.
- 16 gauge continuous hinges.
- Corner foot gussets provide added rigidity and stability (replaced by mounting plates on mobile units).
- Mobile units include four heavy-duty locking swivel casters.
- Positive three-point locking (top, center and bottom) for secure locking.
- Plated locking handle has built-in cylinder key lock (keys included).

**QUICKSHIP**

# 800 SERIES INDUSTRIAL STRENGTH STEEL CABINETS



800 SERIES INDUSTRIAL CABINETS

**PROVIDES MAXIMUM PROTECTION TO TOOLS, DIES, DELICATE INSTRUMENTS, SUPPLIES, AND PERSONAL BELONGINGS.****DESIGNED TO MEET GOVERNMENT REQUIREMENTS.**

| 800 SERIES INDUSTRIAL STRENGTH STEEL CABINETS |       |       |        |                    |                   |                 |
|---|-------|-------|--------|--------------------|-------------------|-----------------|
| Description                                   | Width | Depth | Height | Knock-Down Cat No. | Assembled Cat No. | Color Selection |
| <b>SOLID DOOR CABINETS</b>                    |       |       |        |                    |                   |                 |
| Stationary, Storage                           | 36    | 18    | 78     | 815S18             | 815S18A           | ME, PT, PL-AM   |
| Stationary, Storage                           | 36    | 24    | 78     | 815S24             | 815S24A           | ME, PT, PL-AM   |
| Stationary, Storage                           | 48    | 18    | 78     | 825S18             | 825S18A           | ME, PT, PL-AM   |
| Stationary, Storage                           | 48    | 24    | 78     | 825S24             | 825S24A           | ME, PT, PL-AM   |
| Stationary, Wardrobe                          | 36    | 18    | 78     | 835W18             | 835W18A           | ME, PT, PL-AM   |
| Stationary, Wardrobe                          | 36    | 24    | 78     | 835W24             | 835W24A           | ME, PT, PL-AM   |
| Stationary, Wardrobe                          | 48    | 18    | 78     | 845W18             | 845W18A           | ME, PT, PL-AM   |
| Stationary, Wardrobe                          | 48    | 24    | 78     | 845W24             | 845W24A           | ME, PT, PL-AM   |
| Stationary, Combination                       | 36    | 18    | 78     | 855C18             | 855C18A           | ME, PT, PL-AM   |
| Stationary, Combination                       | 36    | 24    | 78     | 855C24             | 855C24A           | ME, PT, PL-AM   |
| Stationary, Combination                       | 48    | 18    | 78     | 865C18             | 865C18A           | ME, PT, PL-AM   |
| Stationary, Combination                       | 48    | 24    | 78     | 865C24             | 865C24A           | ME, PT, PL-AM   |
| Mobile, Storage                               | 36    | 24    | 78     | 815S24M            | 815S24MA          | ME, PT, PL-AM   |
| Mobile, Storage                               | 48    | 24    | 78     | 825S24M            | 825S24MA          | ME, PT, PL-AM   |
| <b>SAFETY VIEW DOOR CABINETS</b>              |       |       |        |                    |                   |                 |
| Stationary, Storage                           | 36    | 18    | 78     | 815S18SV           | 815S18SVA         | ME, PT, PL-AM   |
| Stationary, Storage                           | 36    | 24    | 78     | 815S24SV           | 815S24SVA         | ME, PT, PL-AM   |
| Stationary, Storage                           | 48    | 18    | 78     | 825S18SV           | 825S18SVA         | ME, PT, PL-AM   |
| Stationary, Storage                           | 48    | 24    | 78     | 825S24SV           | 825S24SVA         | ME, PT, PL-AM   |
| Stationary, Wardrobe                          | 36    | 18    | 78     | 835W18SV           | 835W18SVA         | ME, PT, PL-AM   |
| Stationary, Wardrobe                          | 36    | 24    | 78     | 835W24SV           | 835W24SVA         | ME, PT, PL-AM   |
| Stationary, Wardrobe                          | 48    | 18    | 78     | 845W18SV           | 845W18SVA         | ME, PT, PL-AM   |
| Stationary, Wardrobe                          | 48    | 24    | 78     | 845W24SV           | 845W24SVA         | ME, PT, PL-AM   |
| Stationary, Combination                       | 36    | 18    | 78     | 855C18SV           | 855C18SVA         | ME, PT, PL-AM   |
| Stationary, Combination                       | 36    | 24    | 78     | 855C24SV           | 855C24SVA         | ME, PT, PL-AM   |
| Stationary, Combination                       | 48    | 18    | 78     | 865C18SV           | 865C18SVA         | ME, PT, PL-AM   |
| Stationary, Combination                       | 48    | 24    | 78     | 865C24SV           | 865C24SVA         | ME, PT, PL-AM   |
| Mobile, Storage                               | 36    | 24    | 78     | 815S24SVM          | 815S24SVMA        | ME, PT, PL-AM   |
| Mobile, Storage                               | 48    | 24    | 78     | 825S24SVM          | 825S24SVMA        | ME, PT, PL-AM   |
| <b>VENTILATED DOOR CABINETS</b>               |       |       |        |                    |                   |                 |
| Stationary, Storage                           | 36    | 18    | 78     | 815S18EV           | 815S18EVA         | ME, PT, PL-AM   |
| Stationary, Storage                           | 36    | 24    | 78     | 815S24EV           | 815S24EVA         | ME, PT, PL-AM   |
| Stationary, Storage                           | 48    | 18    | 78     | 825S18EV           | 825S18EVA         | ME, PT, PL-AM   |
| Stationary, Storage                           | 48    | 24    | 78     | 825S24EV           | 825S24EVA         | ME, PT, PL-AM   |
| Stationary, Wardrobe                          | 36    | 18    | 78     | 835W18EV           | 835W18EVA         | ME, PT, PL-AM   |
| Stationary, Wardrobe                          | 36    | 24    | 78     | 835W24EV           | 835W24EVA         | ME, PT, PL-AM   |
| Stationary, Wardrobe                          | 48    | 18    | 78     | 845W18EV           | 845W18EVA         | ME, PT, PL-AM   |
| Stationary, Wardrobe                          | 48    | 24    | 78     | 845W24EV           | 845W24EVA         | ME, PT, PL-AM   |
| Stationary, Combination                       | 36    | 18    | 78     | 855C18EV           | 855C18EVA         | ME, PT, PL-AM   |
| Stationary, Combination                       | 36    | 24    | 78     | 855C24EV           | 855C24EVA         | ME, PT, PL-AM   |
| Stationary, Combination                       | 48    | 18    | 78     | 865C18EV           | 865C18EVA         | ME, PT, PL-AM   |
| Stationary, Combination                       | 48    | 24    | 78     | 865C24EV           | 865C24EVA         | ME, PT, PL-AM   |
| Mobile, Storage                               | 36    | 24    | 78     | 815S24EVM          | 815S24EVMA        | ME, PT, PL-AM   |
| Mobile, Storage                               | 48    | 24    | 78     | 825S24EVM          | 825S24EVMA        | ME, PT, PL-AM   |

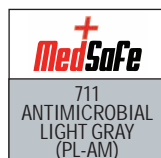
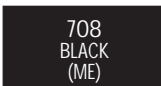

Order your cabinets in our specially formulated Antimicrobial powder coat finish that protects against bacteria, mold & yeast for up to 20 years!



**QUICKSHIP**

## CLASSIC AND GALVANITE™ SERIES ALL-WELDED CABINETS

# DURATOUGH™

*For Really Tough  
Industrial Applications*

**KD KNOCK DOWN  
ASSEMBLY**



Storage Cabinet

16 gauge Classic & Galvanite™  
14 gauge Classic & Galvanite™  
12 gauge Classic & Galvanite™



Combination Cabinet

16 gauge Classic & Galvanite™  
14 gauge Classic & Galvanite™  
12 gauge Classic & Galvanite™

### GENERAL SPECIFICATIONS

**CLASSIC SERIES CABINETS** are fabricated from prime grade cold rolled sheet steel.

**GALVANITE SERIES CABINETS** are fabricated from galvanized sheet steel which has a zinc-iron alloy coating that is applied at the mill providing protection against high-humidity and moist environments. This coating also prevents corrosion from spreading when the paint and/or coating is scratched away.

**HEAVY-DUTY CABINETS** are 16 gauge with 16 gauge shelves

**EXTRA HEAVY-DUTY CABINETS** are 14 gauge with 14 gauge shelves

**SUPER-DUTY CABINETS** are 12 gauge with 14 gauge shelves  
**SAFETY-VIEW® SERIES CABINETS** incorporate polycarbonate panels in both doors of our extra heavy-duty 14 gauge Classic Series cabinets allowing contents to be visible without compromising security.

**VENTILATED SERIES CABINETS** are fabricated to the same rugged standards as our extra heavy-duty 14 gauge Classic Series cabinets with the added benefit of being fully ventilated with diamond perforated doors and sides and a 13 gauge flattened expanded metal back.



738  
CHARCOAL  
(CL)



**QUICKSHIP**

## CLASSIC AND GALVANITE™ SERIES ALL-WELDED CABINETS

# DURATOUGH™

All the rugged standard features of our popular Classic Series DuraTough cabinets with the added strength and security of 12 gauge sides and doors.



Safety-View Cabinet  
14 gauge Classic



Ventilated Cabinet  
14 gauge Classic



18-gauge full-height door stiffener provides maximum rigidity to both doors

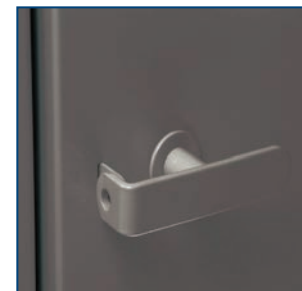

Heavy-Duty 3/16" thick steel handle with padlock hasp

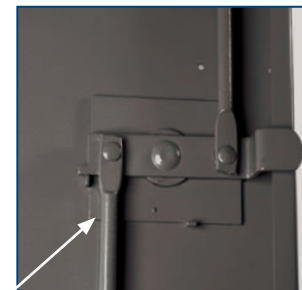

1/8" thick latch and 3/8" diameter lock rods insure maximum security

### STANDARD FEATURES FOR ALL DURATOUGH™ CLASSIC AND GALVANITE™ SERIES CABINETS

- All-welded construction
- Double door design
- Solid doors are reinforced with an 18 gauge full-height door stiffener providing a rigid torque-free door.
- 3-point turn handle locking using 3/8" diameter locking rods operated by a 3/16" gauge steel handle. Handle is painted to match cabinet.
- Heavy-duty 13 gauge 7-knuckle 3-1/2" butt hinges welded to door and securely riveted to frame.
- Solid sides are formed to be integral with vertical door frame.
- Top is formed to be integral with horizontal top door frame.
- Bottom is formed to be integral with horizontal bottom door frame and includes double return bends at all four sides maximizing unit rigidity.
- Back is welded to cabinet top, bottom and sides
- Shelves are formed to provide maximum capacity and are adjustable on 3" centers. Shelves bolt to shelf support channels which are welded to sides.
- 78" high storage cabinets include 4-adjustable shelves
- 60" high storage cabinets include 3-adjustable shelves
- 42" high storage cabinets include 2-adjustable shelves
- 78" high combination cabinets include one full-width upper shelf, a center partition, 3 partial-width shelves and one partial-width coat rod
- Optional leg kits are available and can be bolted on to all DuraTough cabinets.
- Color: 738 Charcoal

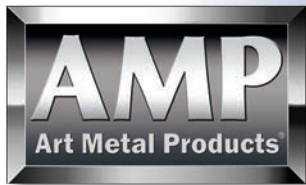

**QUICKSHIP**

## CLASSIC AND GALVANITE™ SERIES ALL-WELDED CABINETS



| DURATOUGH™ CLASSIC SERIES        |             |            |            |             |                |
|----------------------------------|-------------|------------|------------|-------------|----------------|
| Catalog Number                   | Type        | Width (In) | Depth (In) | Height (In) | No. of Shelves |
| <b>16 GAUGE HEAVY-DUTY</b>       |             |            |            |             |                |
| HW6SC6142-2                      | Storage     | 36         | 21         | 42          | 2              |
| HW6SC6160-3                      | Storage     | 36         | 21         | 60          | 3              |
| HW6SC6178-4                      | Storage     | 36         | 21         | 78          | 4              |
| HW6SC6478-4                      | Storage     | 36         | 24         | 78          | 4              |
| HW6SC8460-3                      | Storage     | 48         | 24         | 60          | 3              |
| HW6SC8478-4                      | Storage     | 48         | 24         | 78          | 4              |
| HW6SC0478-4                      | Storage     | 60         | 24         | 78          | 4              |
| HW6CC6478-4                      | Combination | 36         | 24         | 78          | 4              |
| HW6CC8478-4                      | Combination | 48         | 24         | 78          | 4              |
| HW6CC0478-4                      | Combination | 60         | 24         | 78          | 4              |
| <b>14 GAUGE EXTRA HEAVY-DUTY</b> |             |            |            |             |                |
| HW4SC6142-2                      | Storage     | 36         | 21         | 42          | 2              |
| HW4SC6160-3                      | Storage     | 36         | 21         | 60          | 3              |
| HW4SC6178-4                      | Storage     | 36         | 21         | 78          | 4              |
| HW4SC6478-4                      | Storage     | 36         | 24         | 78          | 4              |
| HW4SC8460-3                      | Storage     | 48         | 24         | 60          | 3              |
| HW4SC8478-4                      | Storage     | 48         | 24         | 78          | 4              |
| HW4SC0478-4                      | Storage     | 60         | 24         | 78          | 4              |
| HW4CC6478-4                      | Combination | 36         | 24         | 78          | 4              |
| HW4CC8478-4                      | Combination | 48         | 24         | 78          | 4              |
| HW4CC0478-4                      | Combination | 60         | 24         | 78          | 4              |
| <b>14 GAUGE VENTILATED</b>       |             |            |            |             |                |
| HW4VSC6478-4                     | Storage     | 36         | 24         | 78          | 4              |
| HW4VSC8478-4                     | Storage     | 48         | 24         | 78          | 4              |
| <b>14 GAUGE SAFETY-VIEW®</b>     |             |            |            |             |                |
| HW4SVSC6478-4                    | Storage     | 36         | 24         | 78          | 4              |
| HW4SVSC8478-4                    | Storage     | 48         | 24         | 78          | 4              |
| <b>12 GAUGE SUPER-DUTY</b>       |             |            |            |             |                |
| HW2SC6478-4                      | Storage     | 36         | 24         | 78          | 4              |
| HW2SC8478-4                      | Storage     | 48         | 24         | 78          | 4              |
| HW2SC0478-4                      | Storage     | 60         | 24         | 78          | 4              |
| HW2CC6478-4                      | Combination | 36         | 24         | 78          | 4              |
| HW2CC8478-4                      | Combination | 48         | 24         | 78          | 4              |
| HW2CC0478-4                      | Combination | 60         | 24         | 78          | 4              |

| DURATOUGH™ GALVANITE SERIES      |             |            |            |             |                |
|----------------------------------|-------------|------------|------------|-------------|----------------|
| Catalog Number                   | Type        | Width (In) | Depth (In) | Height (In) | No. of Shelves |
| <b>HEAVY-DUTY-16 GAUGE</b>       |             |            |            |             |                |
| HWG6SC6142-2                     | Storage     | 36         | 21         | 42          | 2              |
| HWG6SC6160-3                     | Storage     | 36         | 21         | 60          | 3              |
| HWG6SC6178-4                     | Storage     | 36         | 21         | 78          | 4              |
| HWG6SC6478-4                     | Storage     | 36         | 24         | 78          | 4              |
| HWG6SC8460-3                     | Storage     | 48         | 24         | 60          | 3              |
| HWG6SC8478-4                     | Storage     | 48         | 24         | 78          | 4              |
| HWG6CC0478-4                     | Storage     | 60         | 24         | 78          | 4              |
| HWG6CC6478-4                     | Combination | 36         | 24         | 78          | 4              |
| HWG6CC8478-4                     | Combination | 48         | 24         | 78          | 4              |
| HWG6CC0478-4                     | Combination | 60         | 24         | 78          | 4              |
| <b>EXTRA HEAVY-DUTY-14 GAUGE</b> |             |            |            |             |                |
| HWG4SC6142-2                     | Storage     | 36         | 21         | 42          | 2              |
| HWG4SC6160-3                     | Storage     | 36         | 21         | 60          | 3              |
| HWG4SC6178-4                     | Storage     | 36         | 21         | 78          | 4              |
| HWG4SC6478-4                     | Storage     | 36         | 24         | 78          | 4              |
| HWG4SC8460-3                     | Storage     | 48         | 24         | 60          | 3              |
| HWG4SC8478-4                     | Storage     | 48         | 24         | 78          | 4              |
| HWG4SC0478-4                     | Storage     | 60         | 24         | 78          | 4              |
| HWG4CC6478-4                     | Combination | 36         | 24         | 78          | 4              |
| HWG4CC8478-4                     | Combination | 48         | 24         | 78          | 4              |
| HWG4CC0478-4                     | Combination | 60         | 24         | 78          | 4              |



738  
CHARCOAL  
(CL)



**QUICKSHIP**

**CLASSIC AND GALVANITE™  
SERIES ALL-WELDED CABINETS**



DURATOUGH ALL-WELDED CABINETS

**DURATOUGH™ CABINET LEG KITS**

| Catalog Number      | Type    | Width (In) | Depth (In) | Height (In) | Legs Per Kit |
|---------------------|---------|------------|------------|-------------|--------------|
| <b>HWC4LK-1G-HG</b> | Leg Kit | 4          | 21         | 4           | 2            |
| <b>HWC4LK-4G-HG</b> | Leg Kit | 4          | 24         | 4           | 2            |

Leg kits can be added to any Hallowell DuraTough Cabinet. Legs are fabricated from galvalneal corrosion resistant steel and are easily bolted to cabinet bottom. Includes hardware for field attachment.

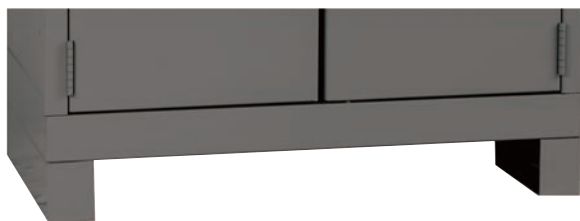

**DURATOUGH™ CABINET DRAWERS**

| Catalog Number     | Type     | Width (In) | Depth (In) | Drawer Height |
|--------------------|----------|------------|------------|---------------|
| <b>FKSCD36-2CL</b> | 2 Drawer | 36         | 24         | 7.5           |
| <b>FKSCD48-2CL</b> | 2 Drawer | 48         | 24         | 7.5           |
| <b>FKSCD36-3CL</b> | 3 Drawer | 36         | 24         | 5             |
| <b>FKSCD48-3CL</b> | 3 Drawer | 48         | 24         | 5             |

Note: Drawer units should always be installed into the lower portion of the cabinets to insure stability when opening the drawers. *Only one drawer should be opened at a time.*



**DURATOUGH™ CLASSIC SERIES - SHELVES**

| Catalog Number  | Type  | Width (In) | Depth (In) | Height (In) | No. of Shelves |
|---|-------|------------|------------|-------------|----------------|
| <b>ADDITIONAL SHELVES, FOR HEAVY-DUTY CABINETS</b>                        |       |            |            |             |                |
| <b>HW6SCS61</b>   | Shelf | 36         | 21         | ---         | 1              |
| <b>HW6SCS64</b>   | Shelf | 36         | 24         | ---         | 1              |
| <b>HW6SCS84</b>   | Shelf | 48         | 24         | ---         | 1              |
| <b>ADDITIONAL SHELVES, FOR EXTRA HEAVY-DUTY &amp; SUPER DUTY CABINETS</b> |       |            |            |             |                |
| <b>HW4SCS61</b>   | Shelf | 36         | 21         | ---         | 1              |
| <b>HW4SCS64</b>   | Shelf | 36         | 24         | ---         | 1              |
| <b>HW4SCS84</b>   | Shelf | 48         | 24         | ---         | 1              |

**DURATOUGH™ GALVANITE SERIES - SHELVES**

| Catalog Number  | Type  | Width (In) | Depth (In) | Height (In) | No. of Shelves |
|---|-------|------------|------------|-------------|----------------|
| <b>ADDITIONAL SHELVES, FOR HEAVY-DUTY CABINETS</b>                        |       |            |            |             |                |
| <b>HWG6SCS61</b>  | Shelf | 36         | 21         | ---         | 1              |
| <b>HWG6SCS64</b>  | Shelf | 36         | 24         | ---         | 1              |
| <b>HWG6SCS84</b>  | Shelf | 48         | 24         | ---         | 1              |
| <b>ADDITIONAL SHELVES, FOR EXTRA HEAVY-DUTY &amp; SUPER DUTY CABINETS</b> |       |            |            |             |                |
| <b>HWG4SCS61</b>  | Shelf | 36         | 21         | ---         | 1              |
| <b>HWG4SCS64</b>  | Shelf | 36         | 24         | ---         | 1              |
| <b>HWG4SCS84</b>  | Shelf | 48         | 24         | ---         | 1              |



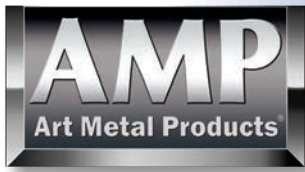

## 24 DESIGNER POWDER COAT FINISHES FOR METAL LOCKERS

Now Available in Standard , Hammertone and Antimicrobial Finishes



742  
Rave Red



721  
Relay Red



727  
Maroon



708  
Black

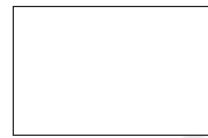

714  
Snow White



738  
Charcoal



743  
Freshwater Blue



731  
Denim Blue



720  
Pep Rally Purple



710  
Sandstone



729  
Tan

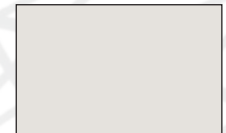

746  
Popular Gray



707  
Marine Blue



717  
Grand Slam Blue



719  
Jersey Blue

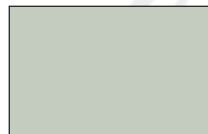

711  
Light Gray



706  
Heather Gray



725  
Dark Gray



744  
Well Bred Brown



745  
Deep Forest Brown



704  
Evergreen



740  
Stardew Gray



741  
Rayo de Sol



728  
Hoop Orange

NOTE: All body components of production KD lockers will be painted our standard neutral color, currently 729 Tan (choice of 729 Tan or 725 Dark Gray for HDV body).

**Enhance your decor with two-tone color combinations, doors one color and frame a second color, AT NO ADDITIONAL COST.**

### HAMMERTONE FINISHES

Specially formulated with a unique hammer texture that is tough, highly durable and provides long lasting protection.

Note: Patterns/colors of textures and metallics will vary due to their nature. No touch up available for hammertone finishes.

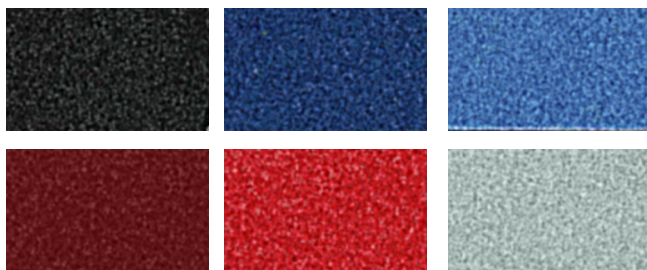

Available for all 24 standard colors



Available for all standard 24 colors

Our MedSafe™ antimicrobial finishes with Microban® are specially formulated to protect against bacteria, mold, yeast & mildew for up to 20 years! Very beneficial for educational, healthcare, food processing and other hygiene conscious environments.

Colors shown are an approximate printed representation of the actual color and will vary depending on light source. Actual color samples are available upon request. Art Metal Products reserves the right to modify its designs and/or make changes in specifications or colors without prior notice.



# VERSAMAX

SOLID PHENOLIC LOCKERS

VersaMax™ lockers use Wilsonart® engineered surfaces, a world leading manufacturer of phenolic products.

## 18 DESIGNER COLORS



# AQUAMAX

HDPE PLASTIC LOCKERS *8 Color Choices*



Colors shown are an approximate representation of the actual color. Please do not make your final color selection from printed media or Internet images, as they may not be 100% accurate. For a more accurate color selection call 1-800-252-5633 or e-mail us at info@ArtMetalProducts.com to request actual color samples.



**STANDARD KD**  
Wardrobe & Box Lockers

**BLACK TIE**  
Commercial Lockers

**STAINLESS STEEL**  
Wardrobe & Box Lockers

**SAFETY-VIEW®**  
Wardrobe Lockers

**SAFETY-VIEW® PLUS**  
Box Lockers

**DIGITECH™ SAFETY-VIEW®**  
Electronic Box Lockers

**MEDSAFE™**  
Antimicrobial Lockers



**READYBUILT™ & READYBUILT™ II**  
Ready-To-Go Lockers

# QUICKSHIP LOCKERS

## Ship in 5 Days

*Our Quickship stock program is the largest of its kind.*

Our unparalleled array of stock lockers guarantees you getting the locker you need, whether it is plastic, wood or metal, box or wardrobe, high performance or emergency response, open-front or high security, we have the right locker for you

Order from stock and save time and money. Our distribution network, comprised of six (6) strategically located, full service, company owned and operated distribution centers, allows us to ship your order fast and secure. Our products are packaged above industry standards to safeguard your lockers, making sure they arrive in perfect condition. We have been providing the quality you demand, the timeliness you require and the service you deserve for over 80 years.



**CUBIX™**  
Modular Box Lockers



**PE/GYM**  
All-Welded  
Ventilated Lockers

**To see a complete list of stock lockers, visit our website:**

**[www.ArtMetalProducts.com](http://www.ArtMetalProducts.com)**



**MAINTENANCE MAXVIEW™ FREE QUIET™**  
High Visibility Lockers



**SECURITYMAX™**  
High Security Lockers



**CLUB**  
Prestigious  
Wood Lockers



**HYBRID**  
Wood & Metal  
Lockers



**TA-50**  
Ventilated  
Gear Lockers



**RECRUITER™ 2**  
Open-Front Wood  
Sport Lockers



**TURNOUT GEAR**  
All-Welded Firefighter  
Lockers



**VALUEMAX™**  
Economy Lockers



**HDV HEAVY-DUTY**  
Ventilated Lockers



**SINGLE-POINT**  
Welded Lockers



**ROOKIE™**  
Open-Front  
KD Gear Lockers



**GALVANITE™**  
Corrosion Resistant  
Lockers



**LAPTOP/  
BACKPACK**  
Ventilated Charger  
Lockers



**CELLPHONE/  
TABLET**  
Mobile Device Lockers

**QUICK-SHIP BENEFITS**

- ✓ No Setup Charges
- ✓ No Minimum Order Quantity
- ✓ Industry's Best Discount

**ADVANTAGES OF SIX DISTRIBUTION CENTERS**

- ✓ Reduces Freight Cost
- ✓ Reduces Transit Time
- ✓ Minimizes Carrier Handling



**KID/TEEN**  
Home Lockers



**HOME TEAM™**  
Ventilated Home Lockers

**6 Distribution Centers Nationwide**



**UNIFORM EXCHANGE**  
Garment Lockers



**LOCKS**  
Hallowell Electronic & Master Built-in  
Combo & Key, Master Padlock



**BSL**  
Bulk Storage  
Lockers

**TASKFORCE XP™**  
Emergency Response  
Lockers



**BENCHES & PEDESTALS**  
Steel Adjustable, Stainless steel, Cast Iron Extra  
Heavy-Duty, Steel, Movable Aluminum



Phenolic Lockers



**MEDSAFE™ AQUAMAX™**  
HDPE Antimicrobial Lockers



**AQUAMAX™**  
HDPE Plastic Lockers

**Manufacturing Since 1914**

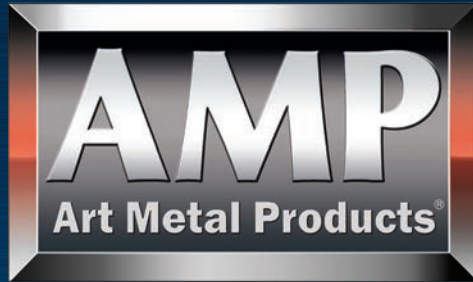

**1-800-252-5633**

**401 Jim Moran Blvd.  
Deerfield Beach, FL 33442**

**[www.ArtMetalProducts.com](http://www.ArtMetalProducts.com)**

Art Metal Products reserves the right to make changes to the information, illustrations, products, services, specifications, availability, plans, and terms and conditions associated with this catalog at any time, without notice, and without incurring obligations or liability of any kind.